



# PHASER

3D **P**RINTED **H**UMANITARIAN **A**ID **S**ETTLEMENTS FOR **E**MERGENCIES **R**ESPONSE

*Contexto de  
emergencias y refugios*



*Investigación*



*Proyecto*





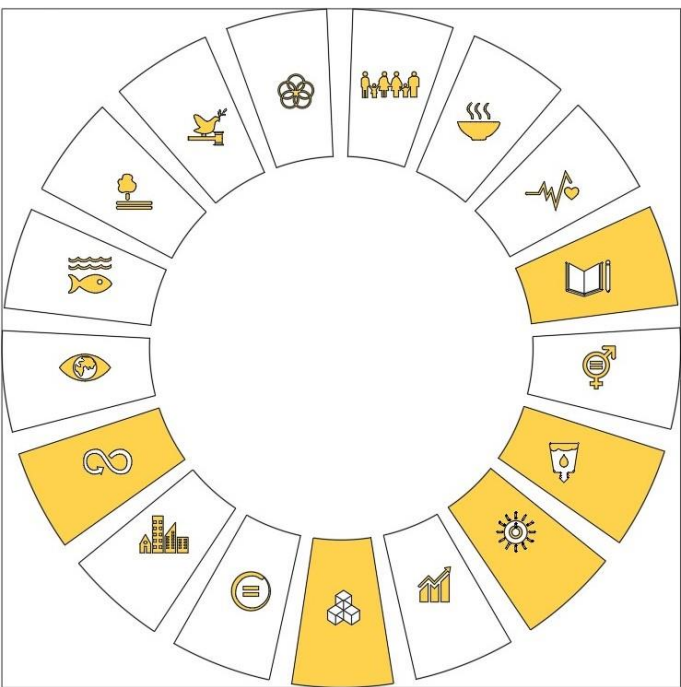
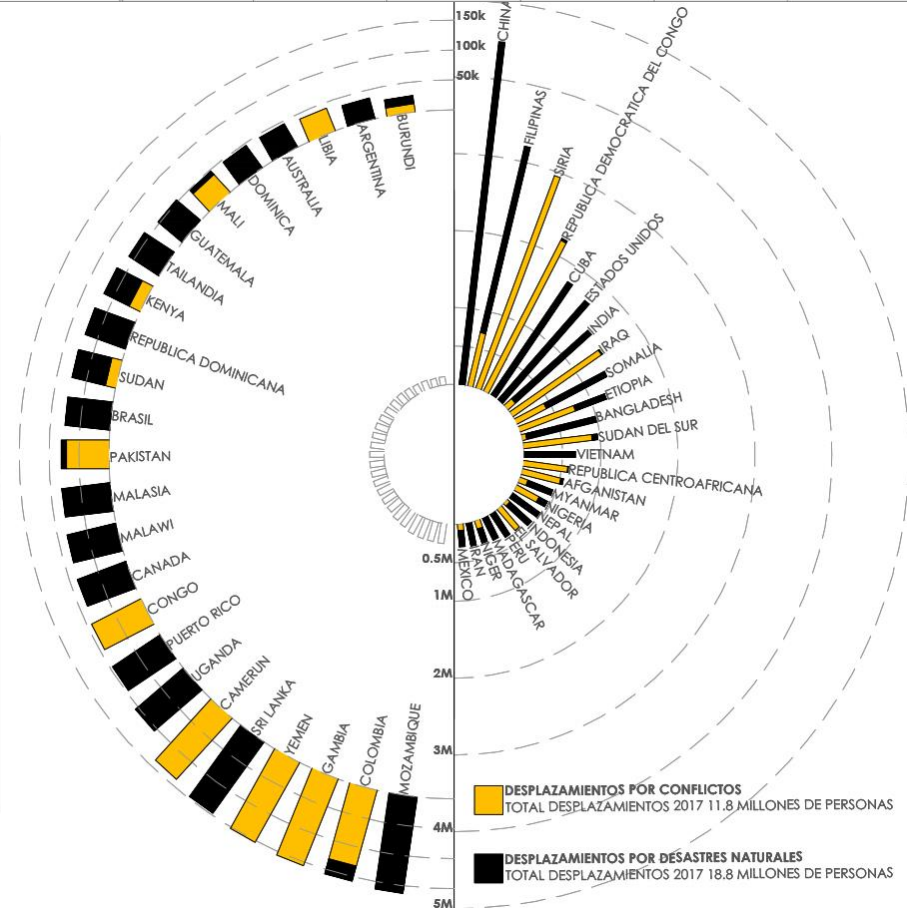
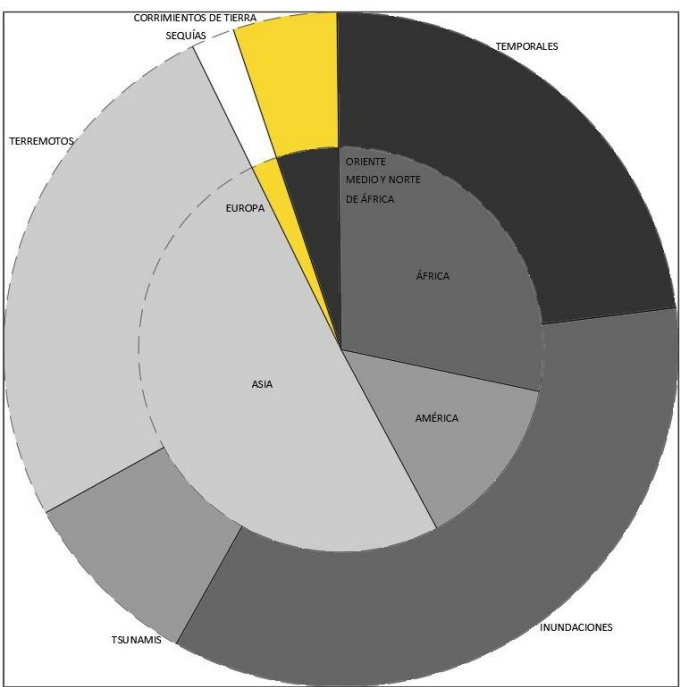
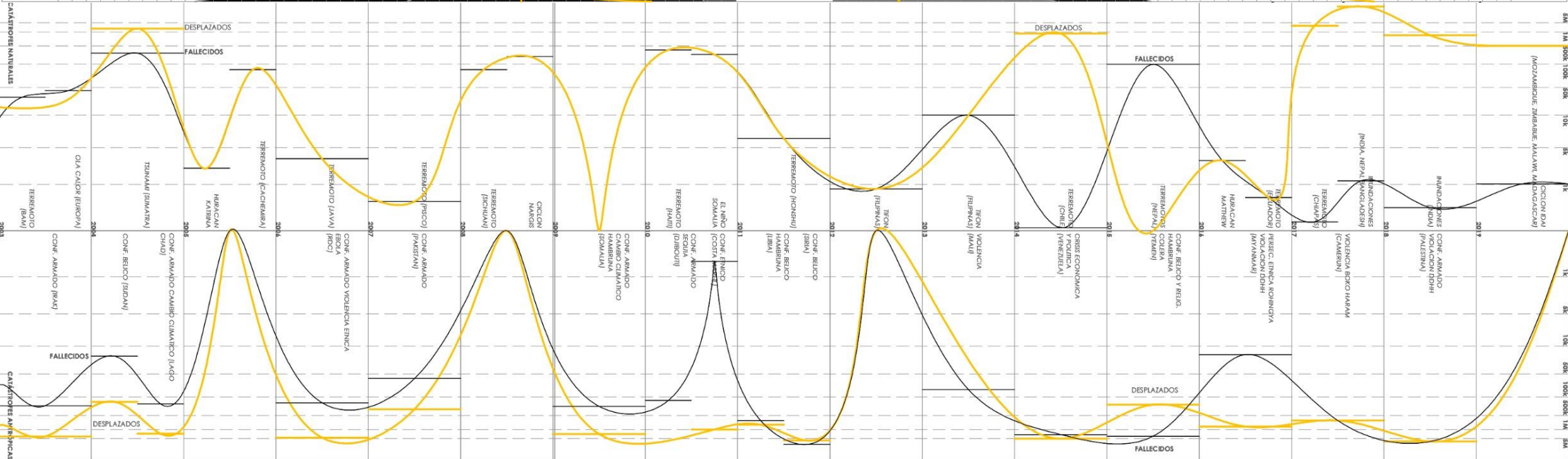
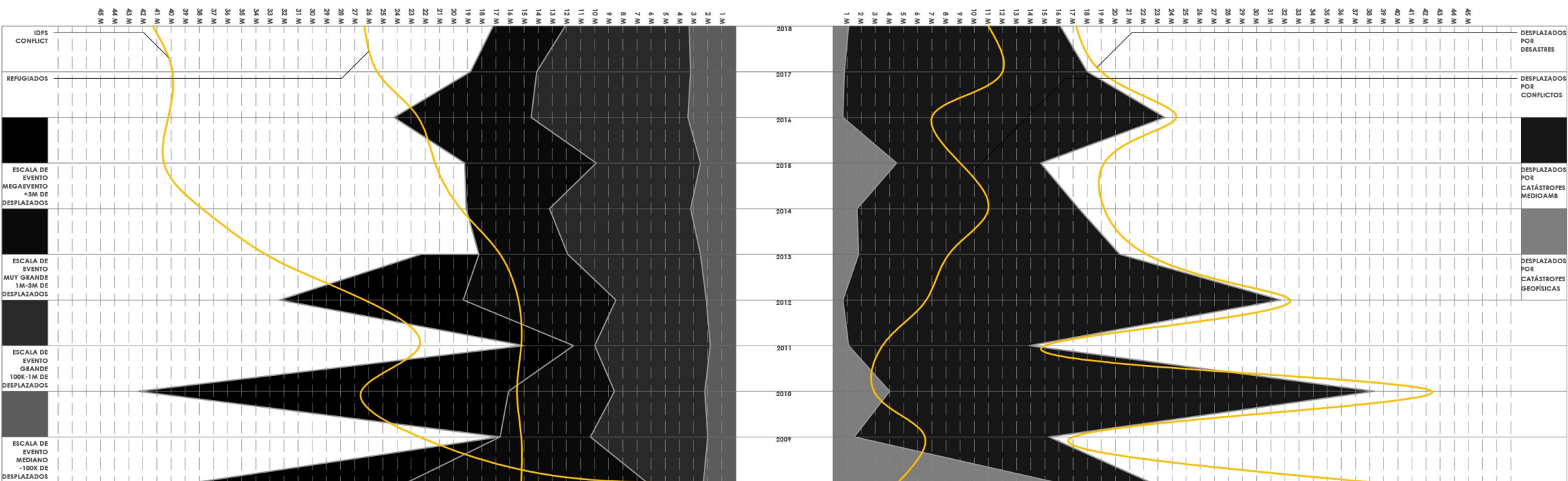

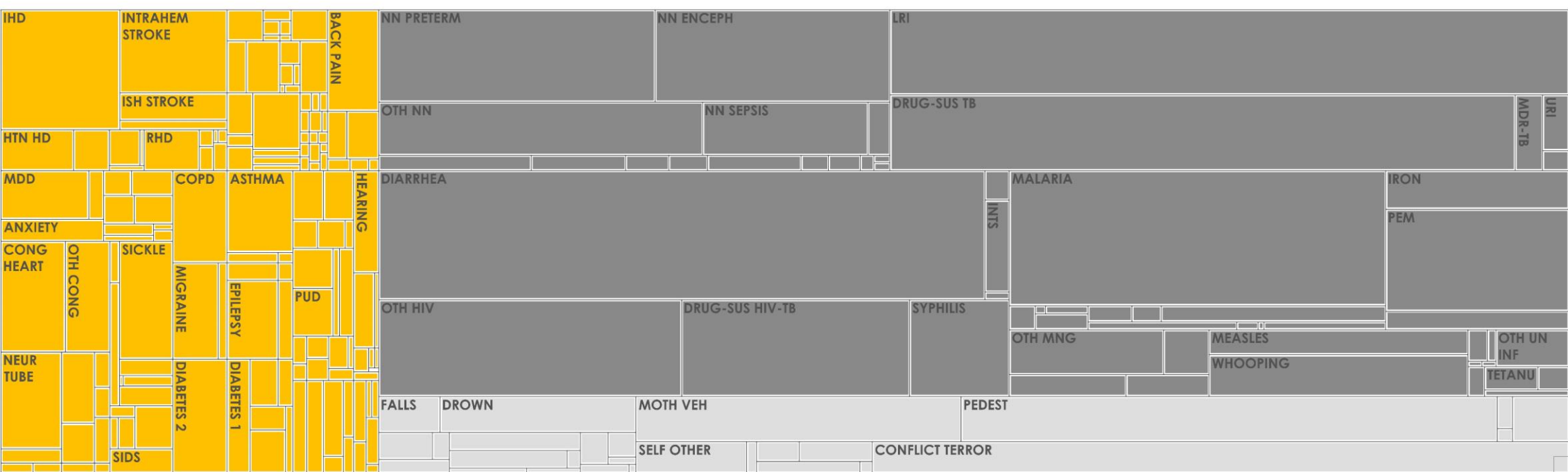
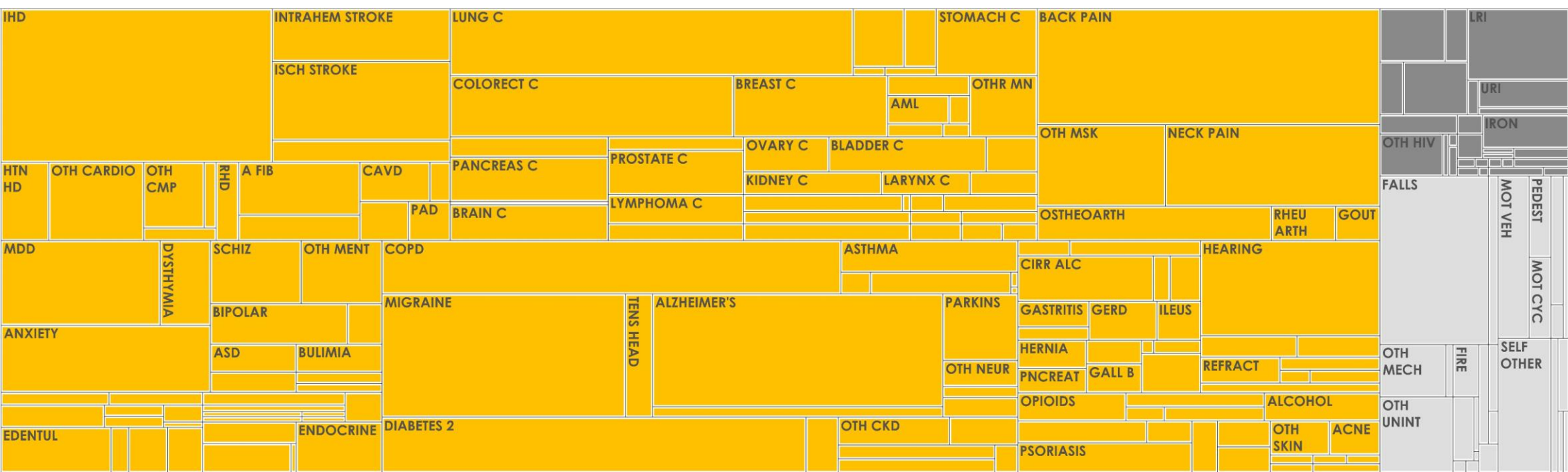



*Supervivencia*



*Contingencia*



*Resiliencia*







# ***PAUTAS PRINCIPALES***

**Ligero**

Unidades mínimas

Versátil

**No requiere de agua**

# ***PAUTAS TANGENCIALES***

Autoportante

Huella ecológica

Reciclable

Lean Manufacturing



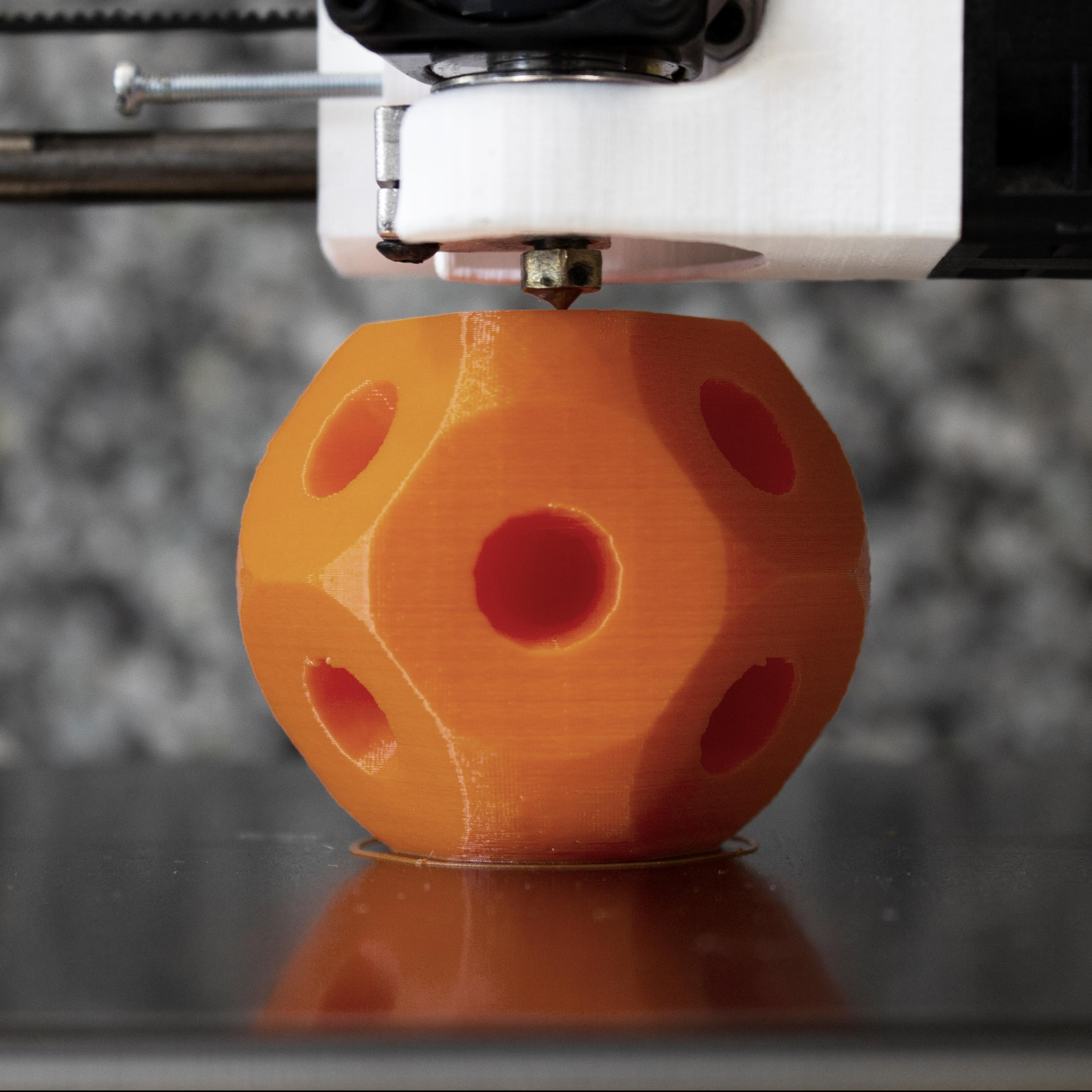



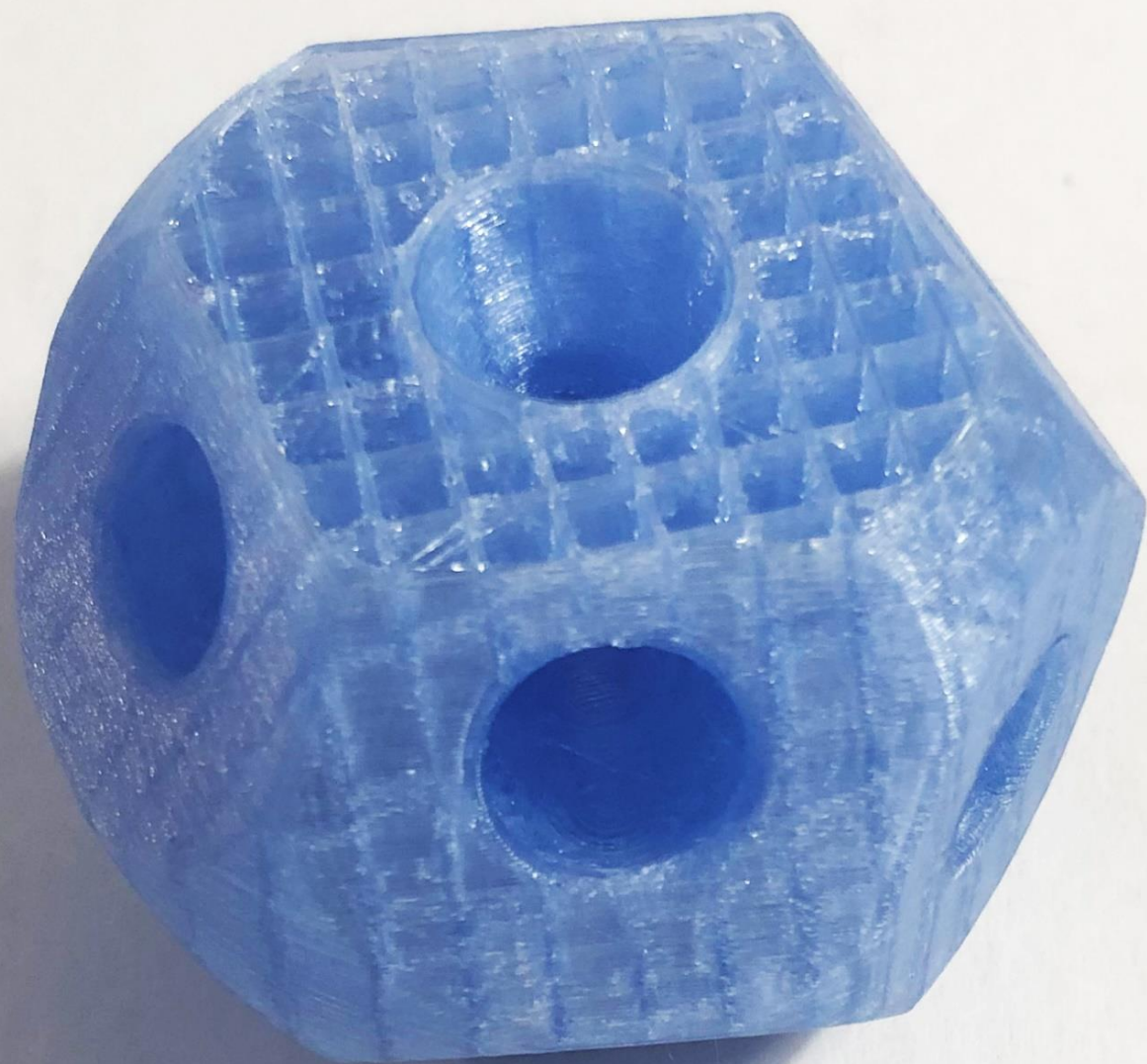



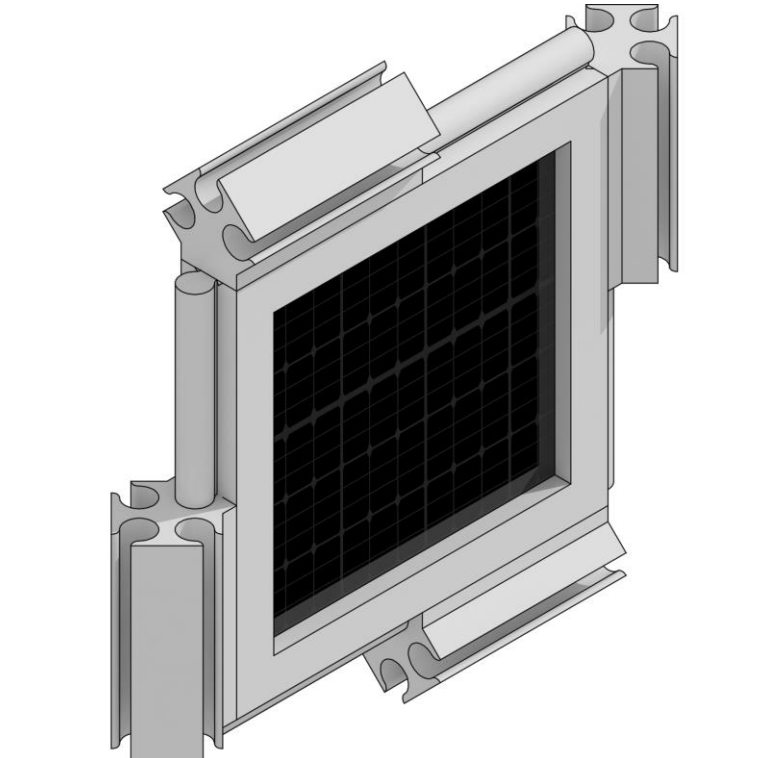
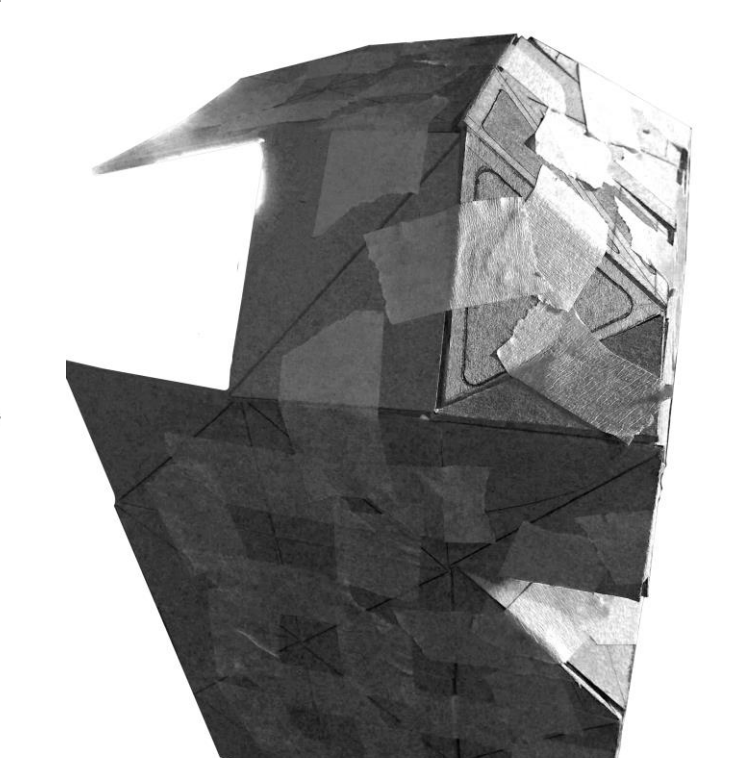
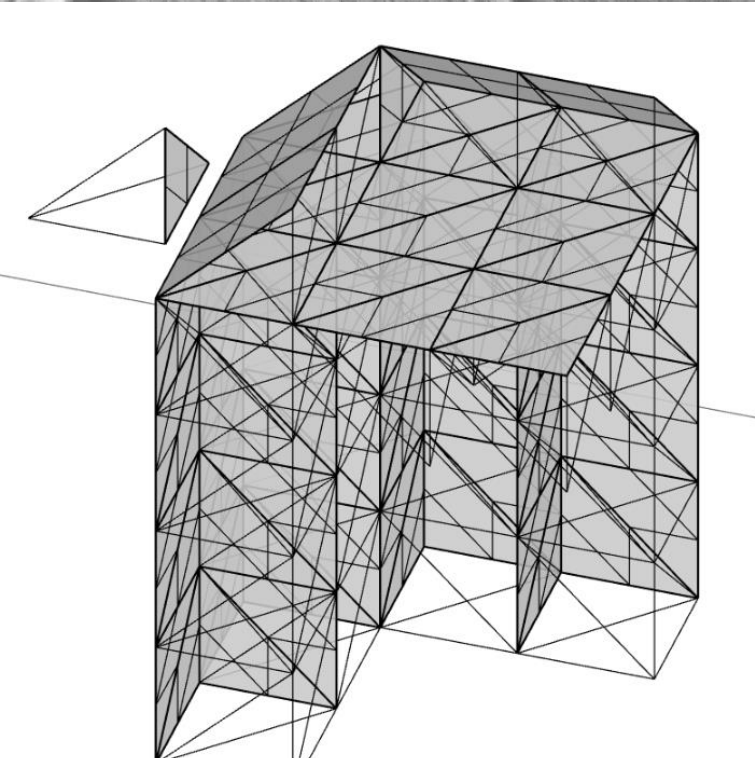
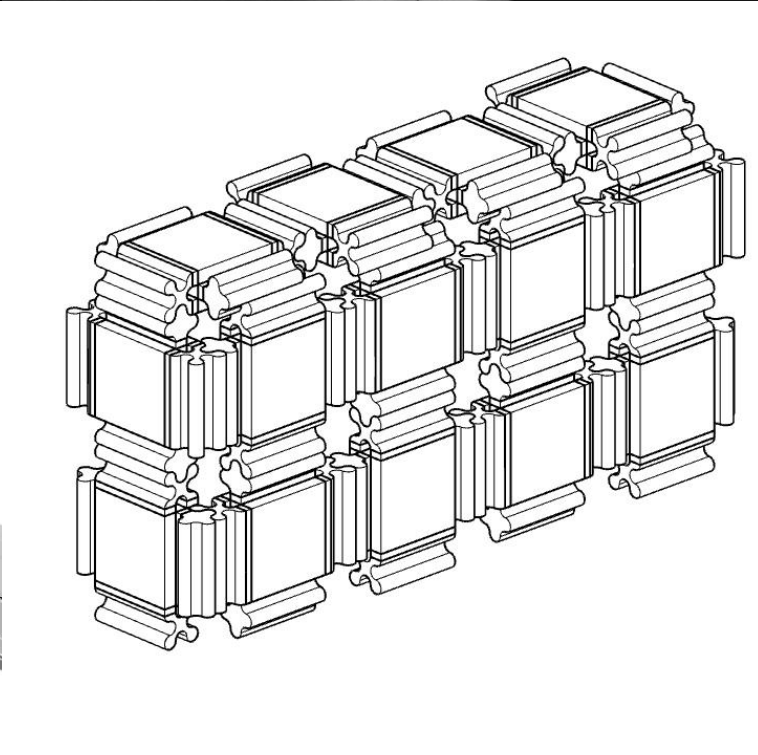
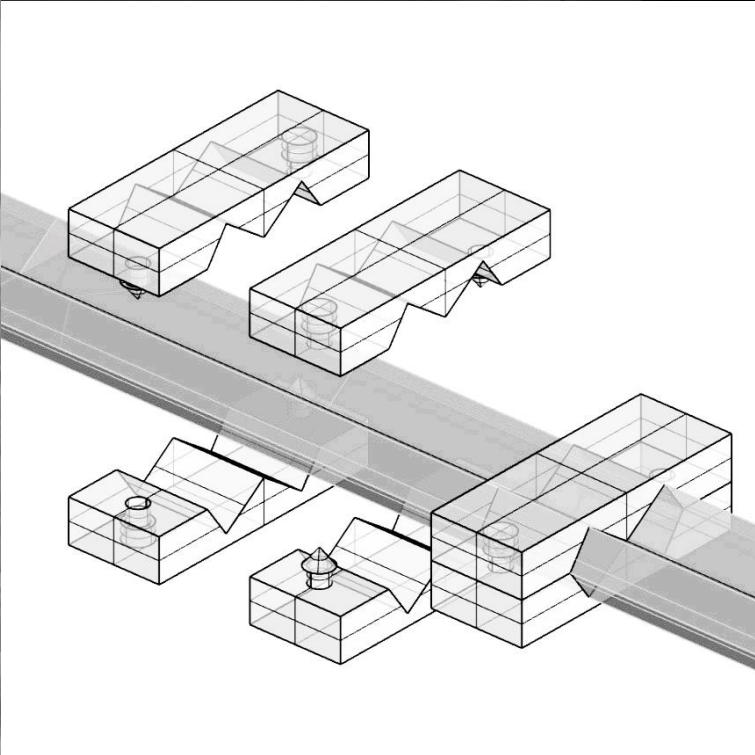
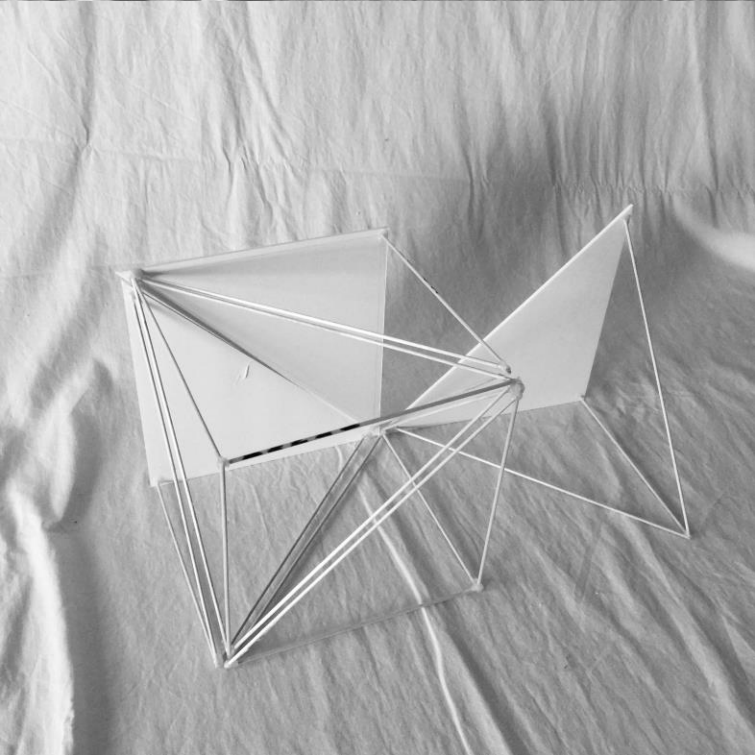
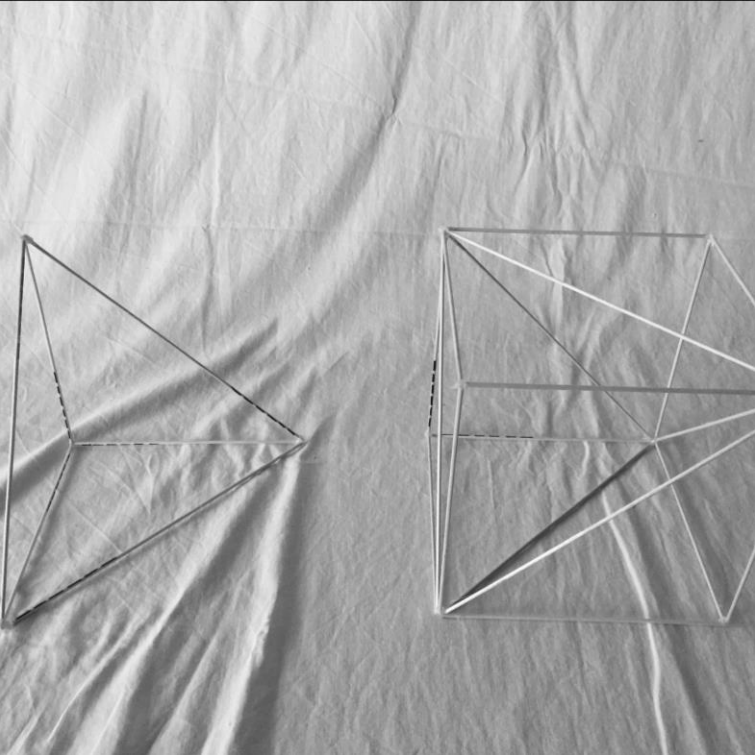



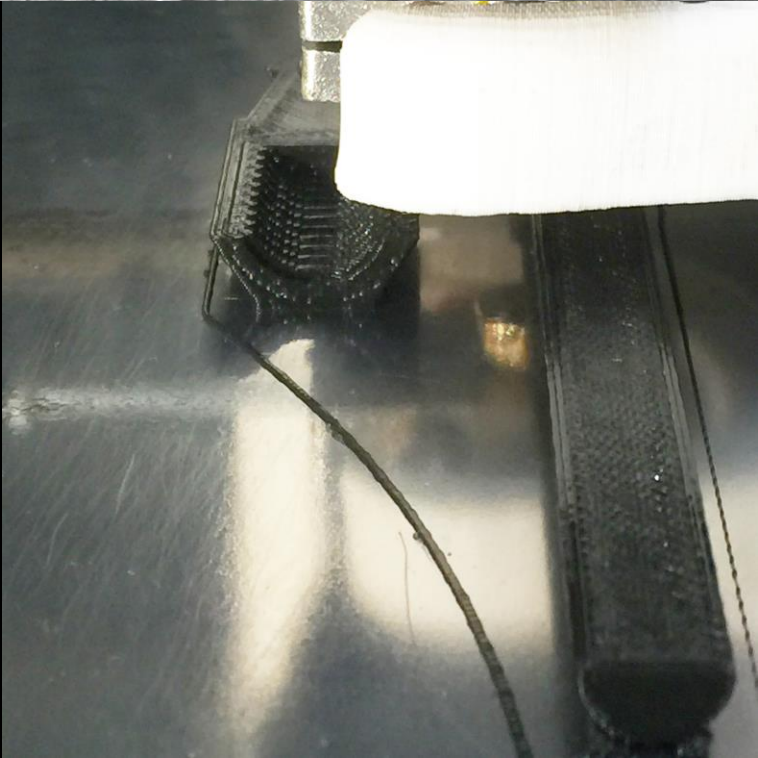
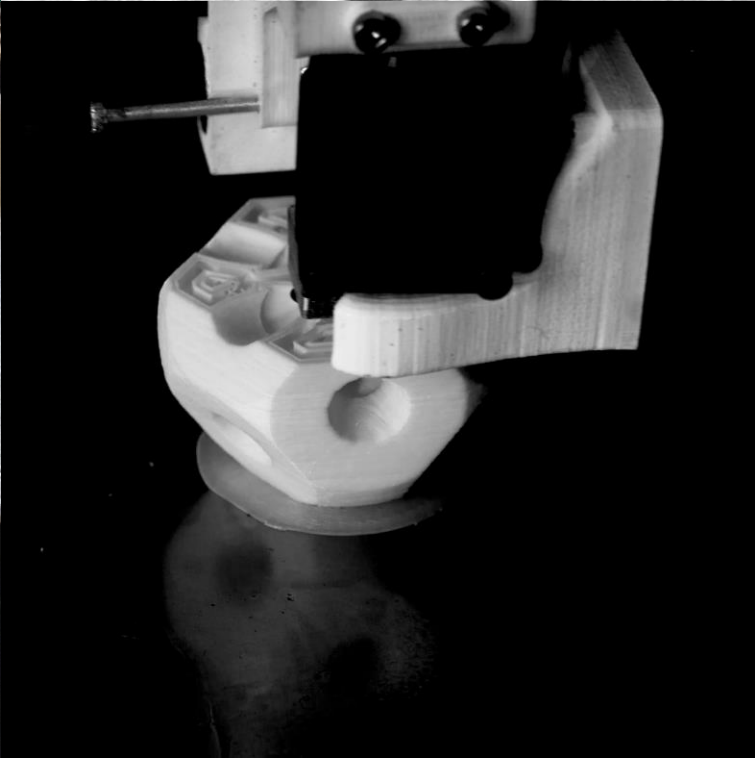
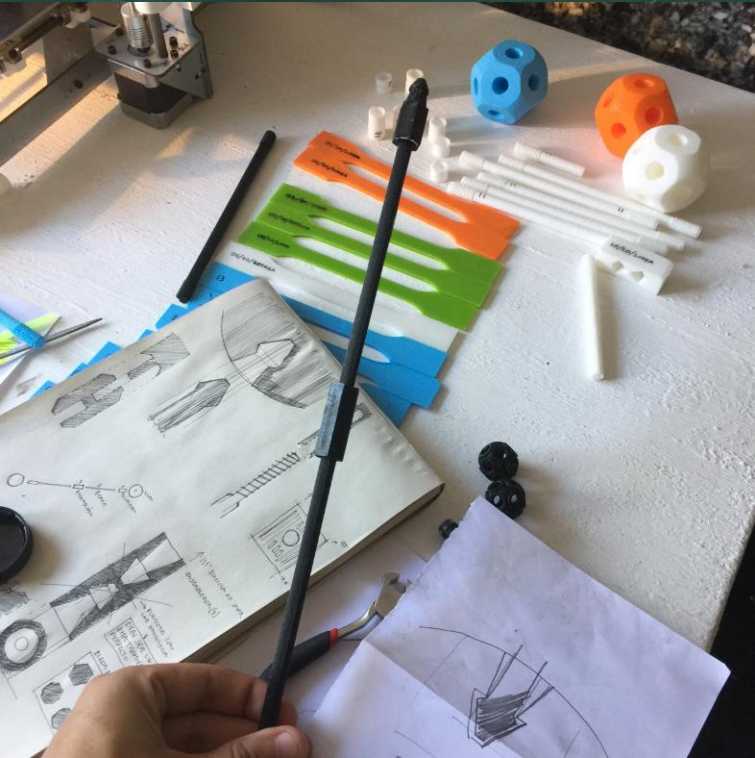
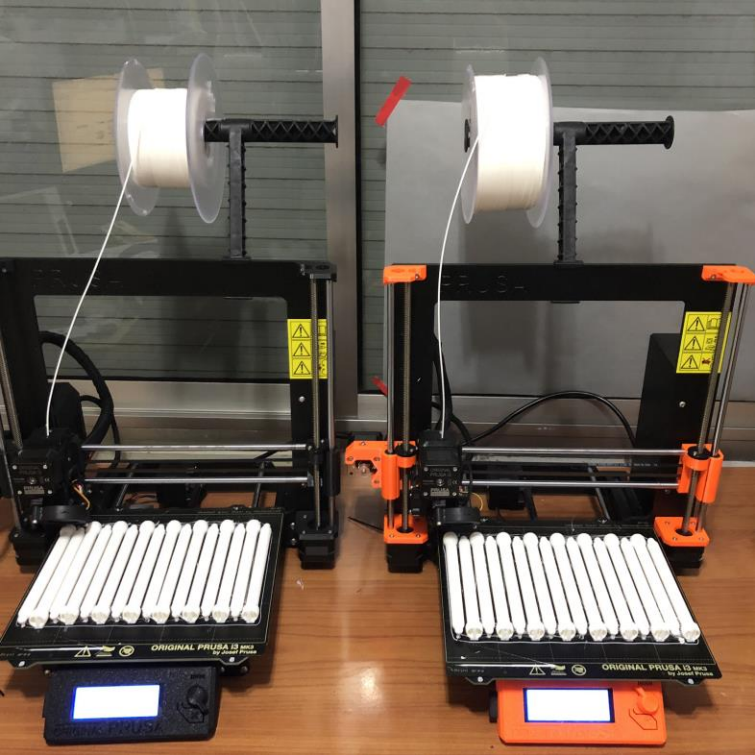



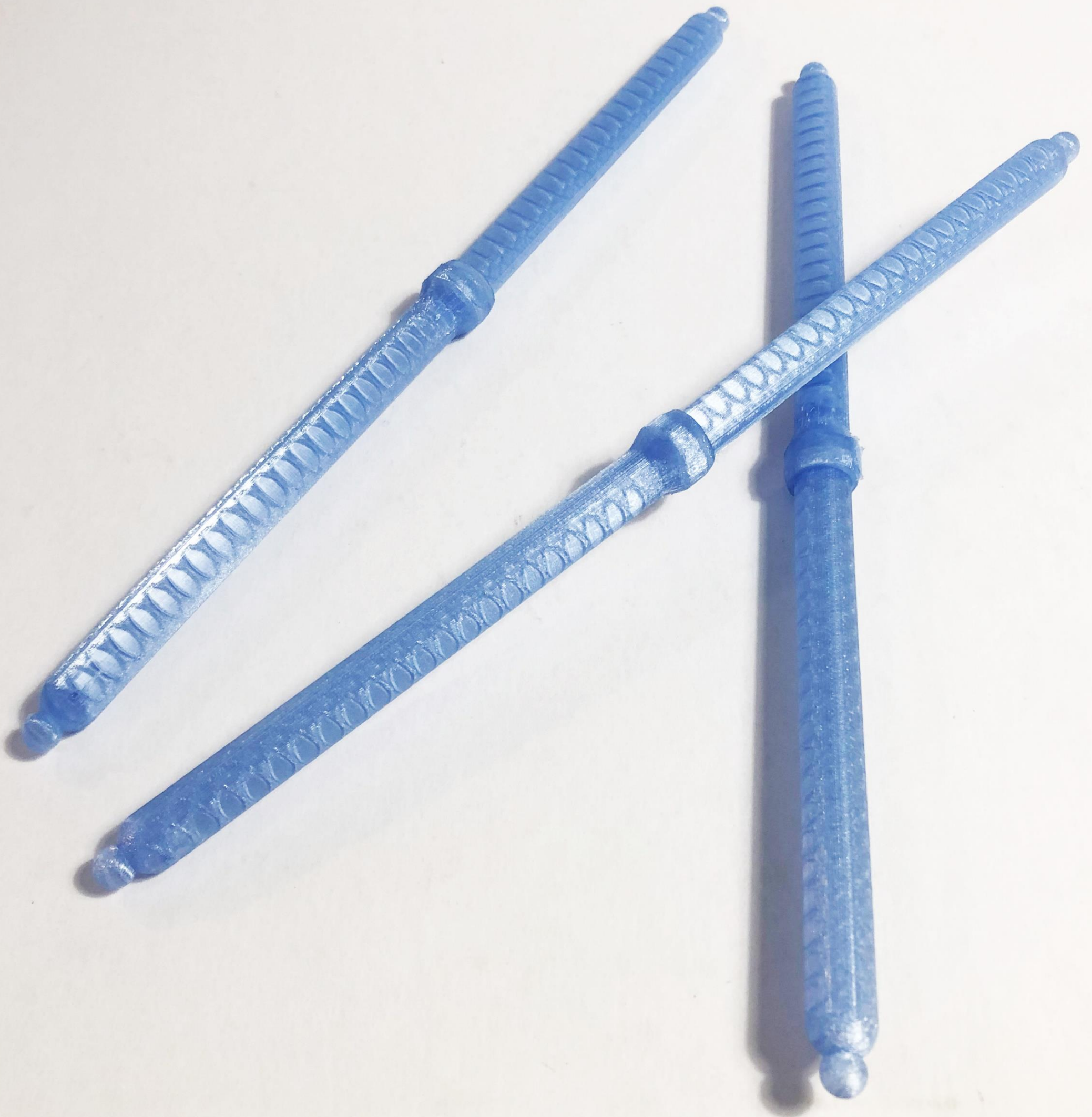

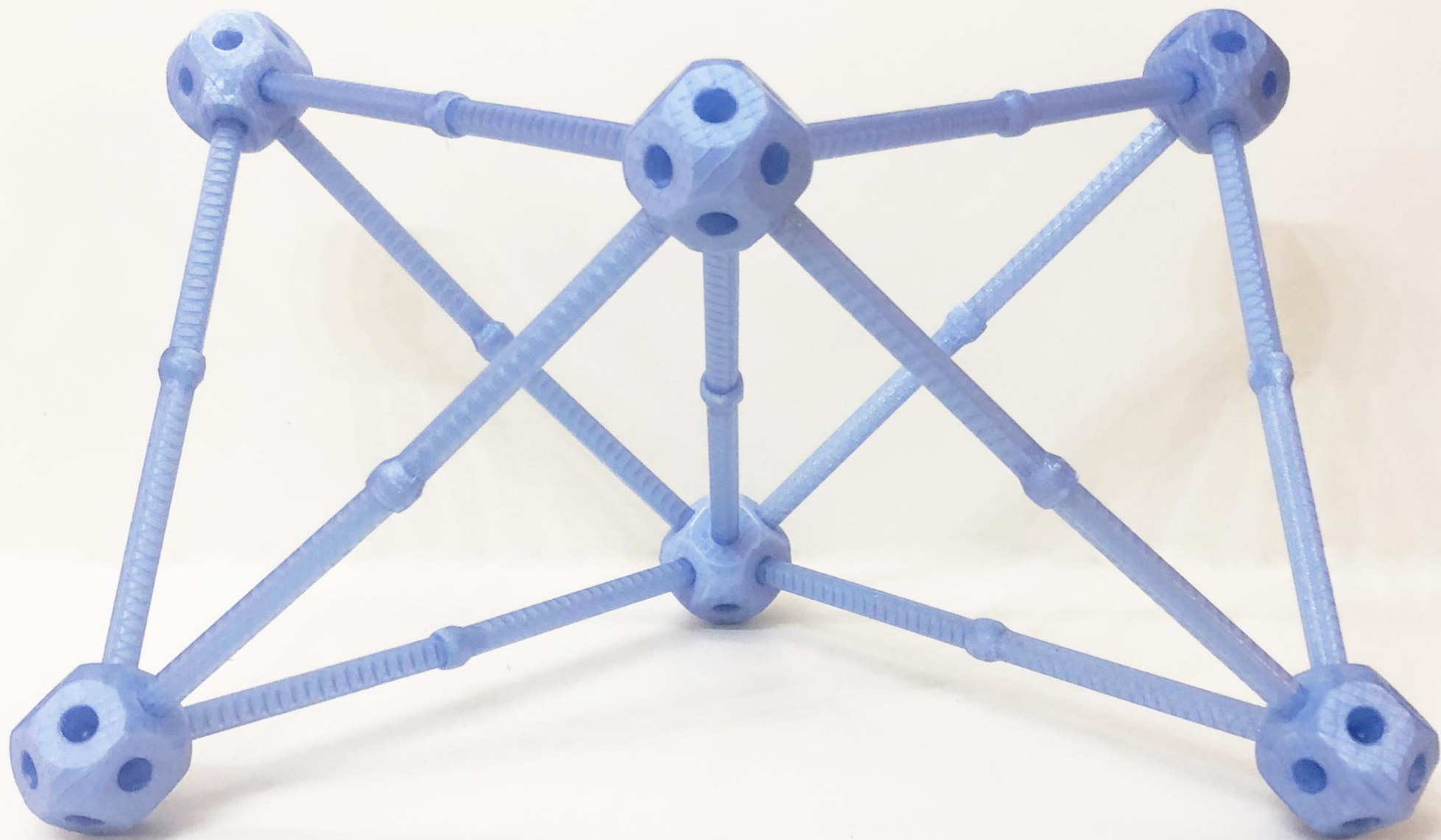



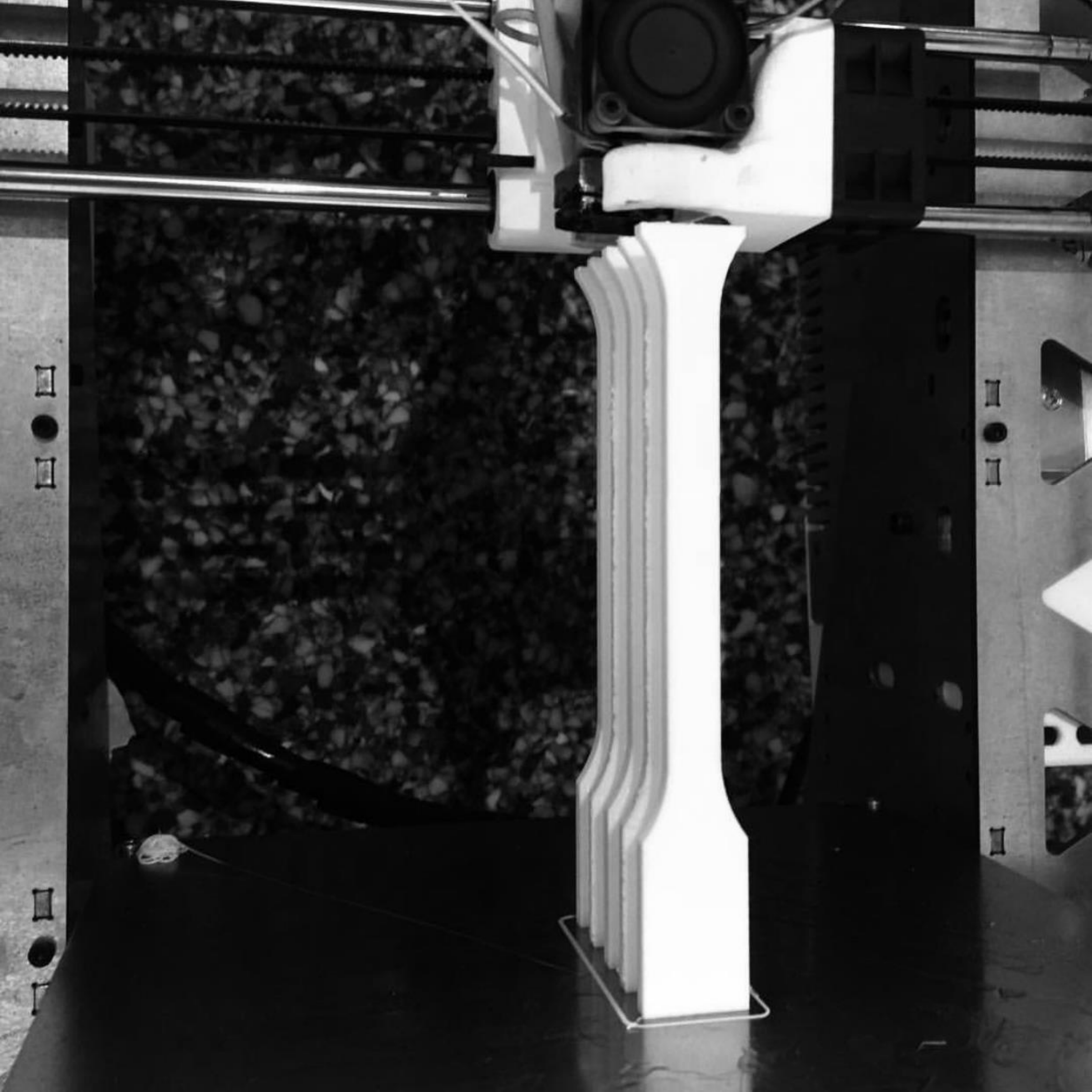





40-R11-1-2

2-V-130-04

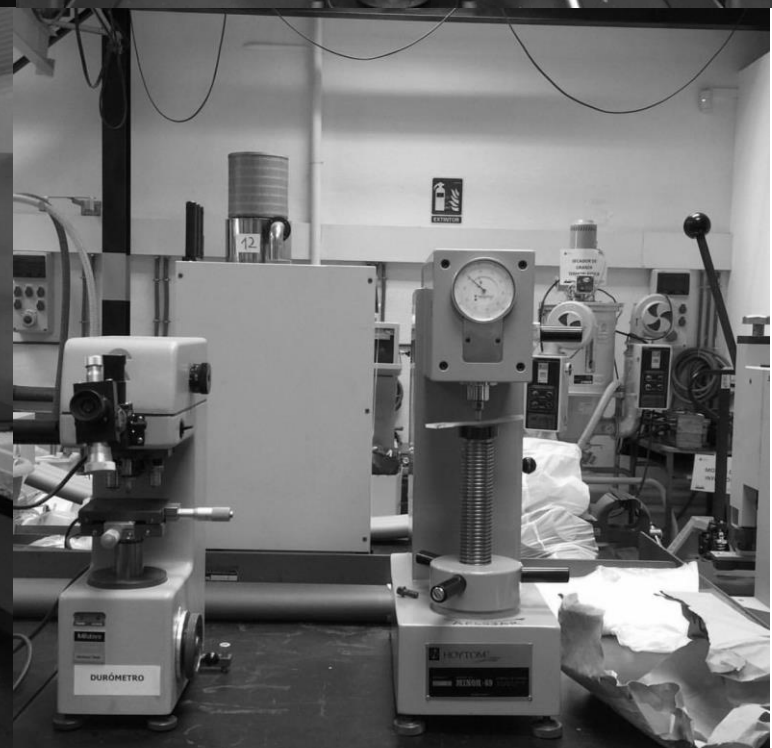
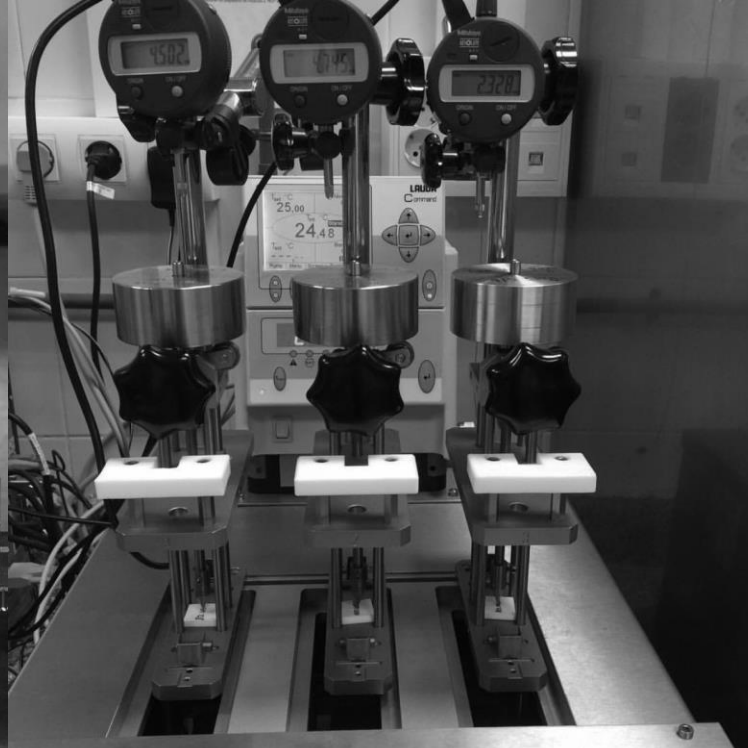



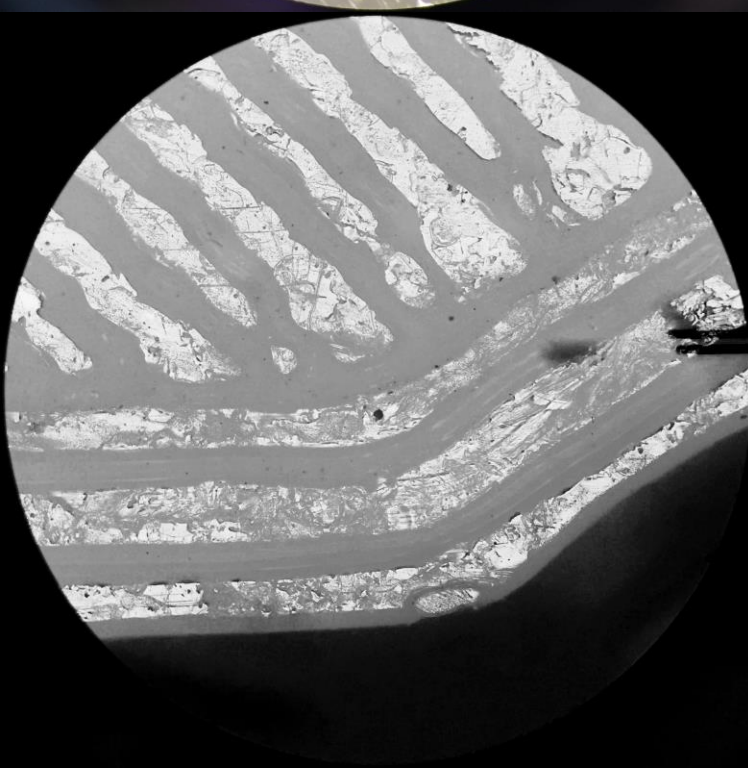
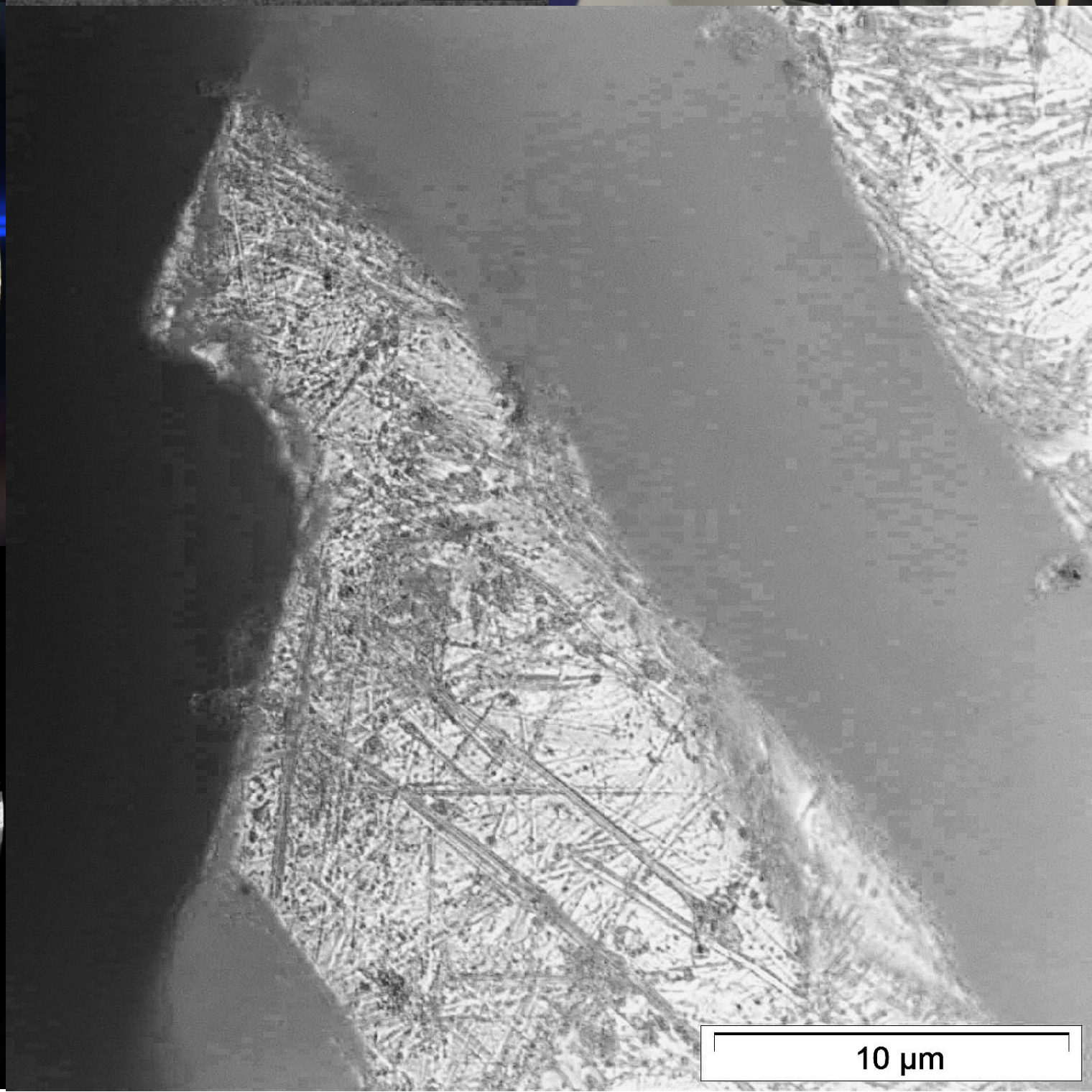
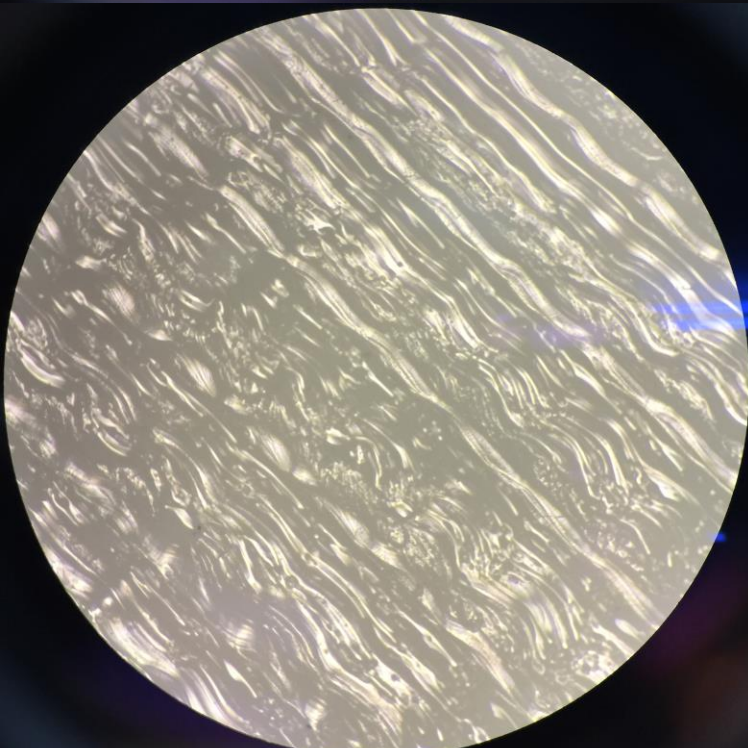
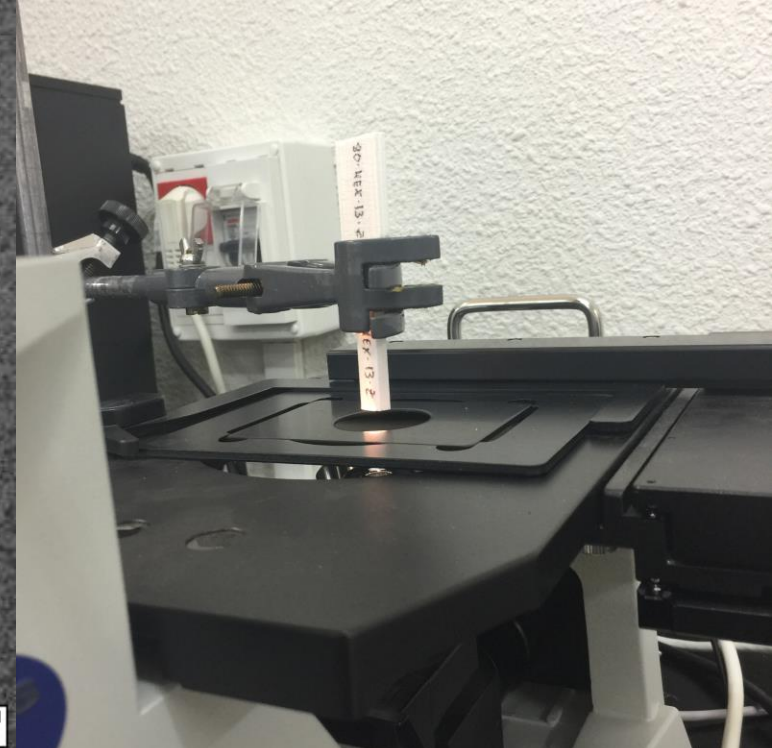
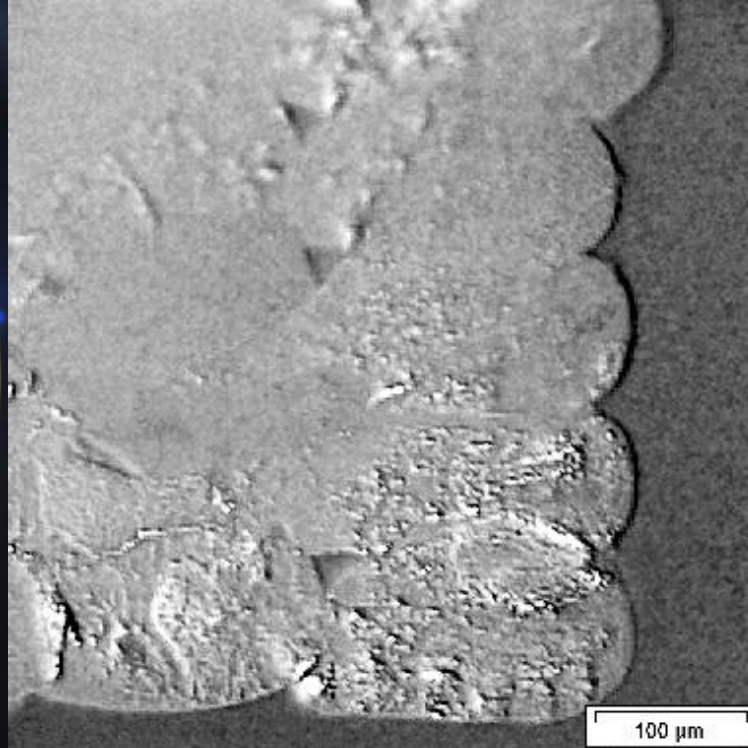



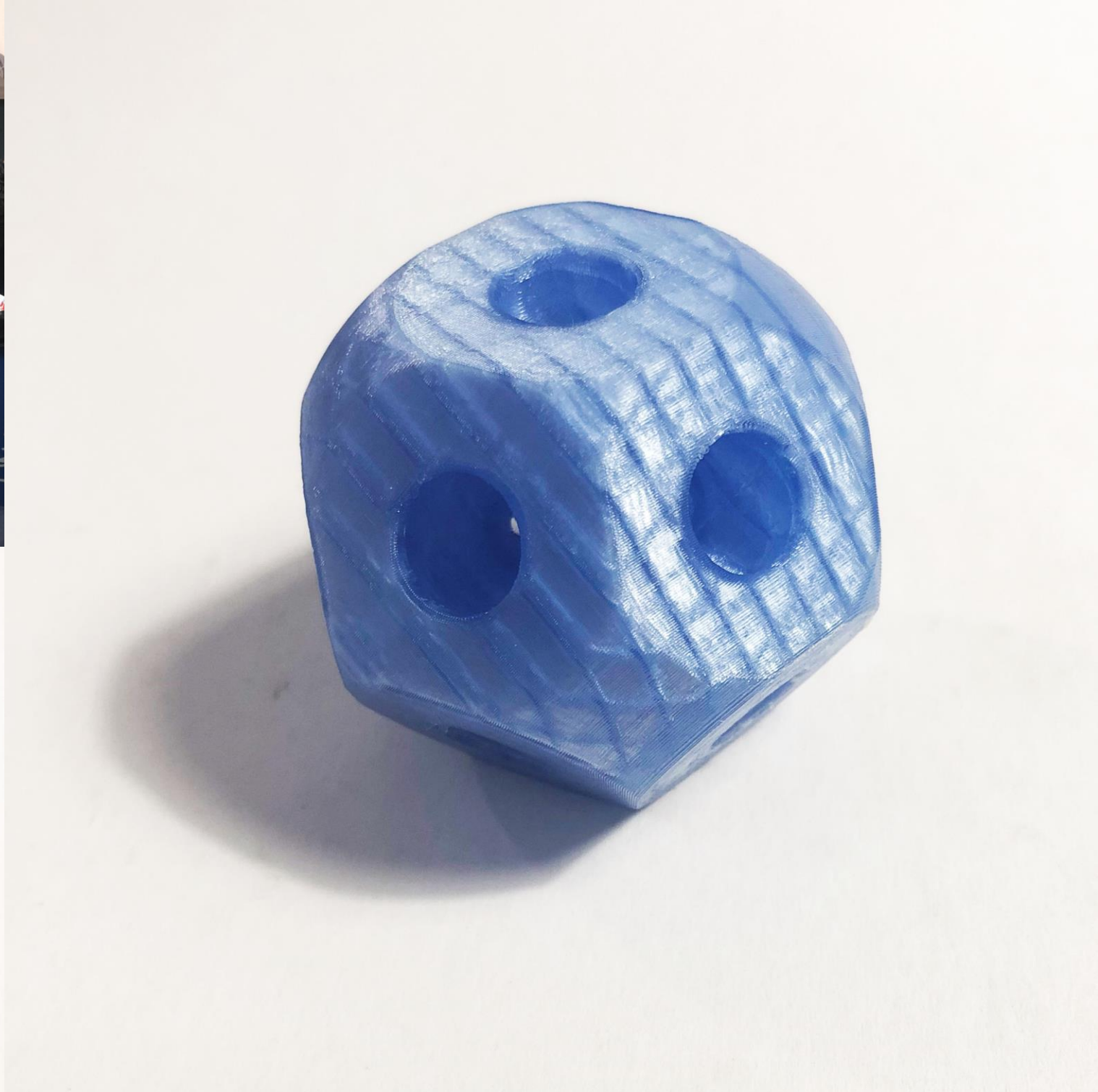



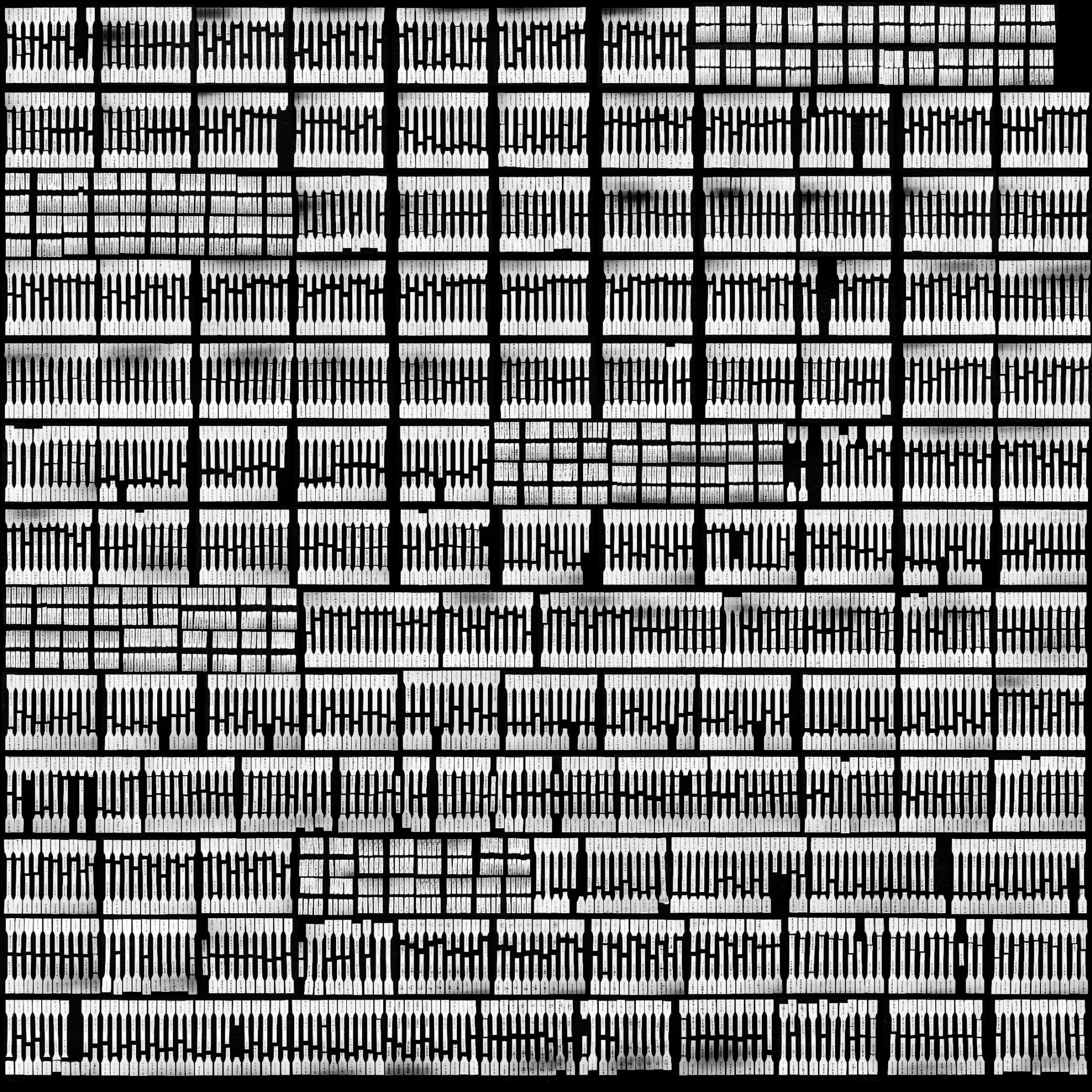







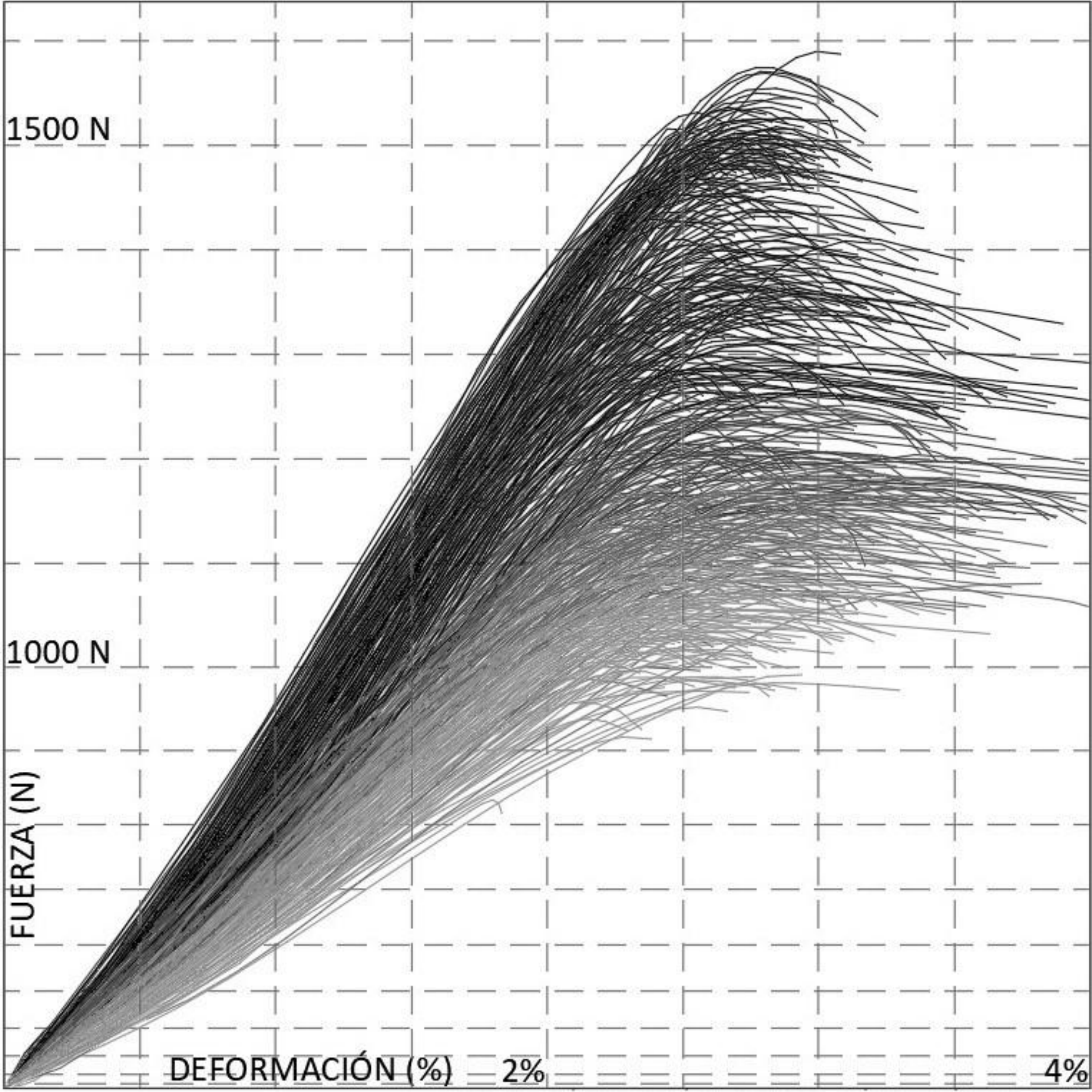



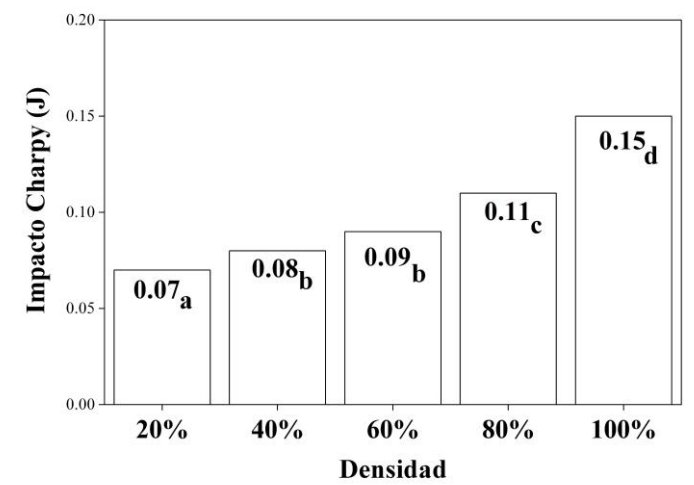
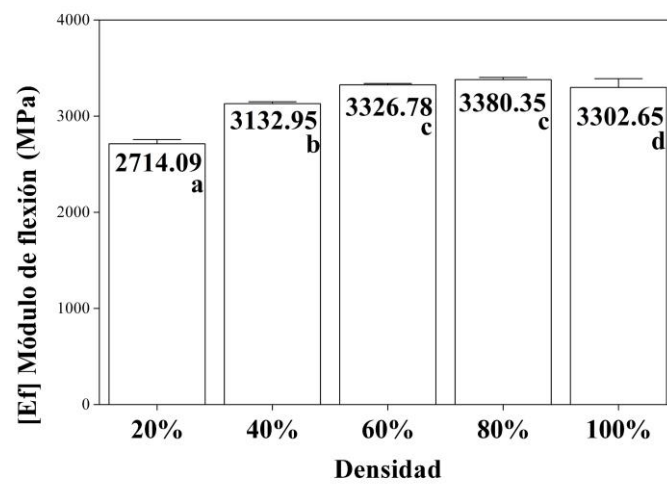
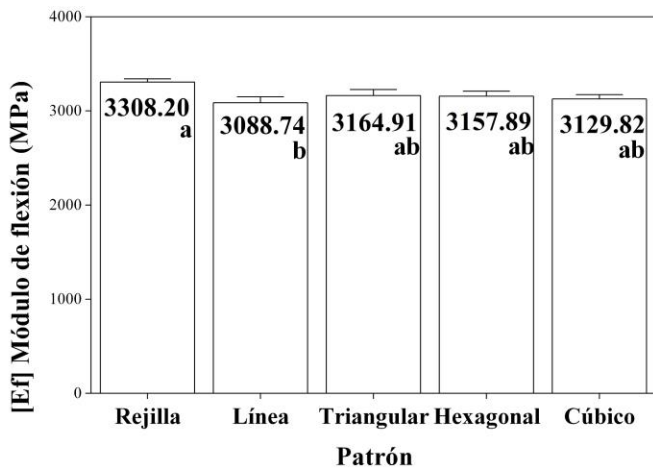

# PATRÓN HEXAGONAL

## DENSIDAD 20%

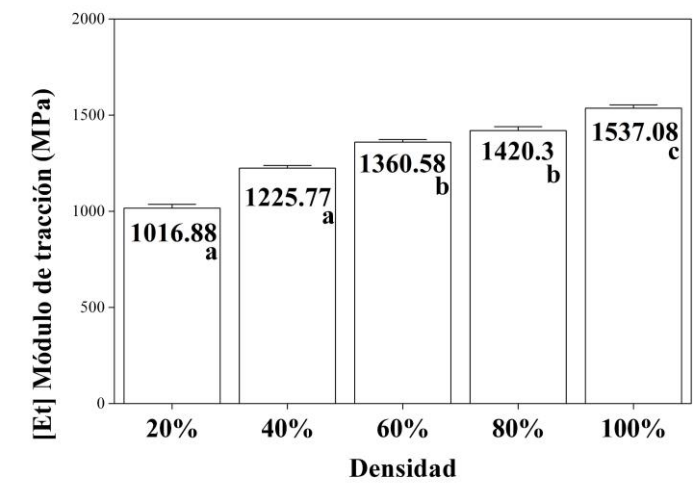
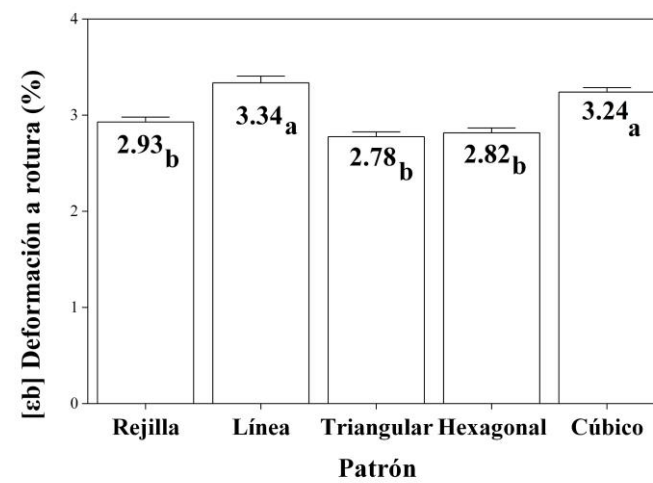
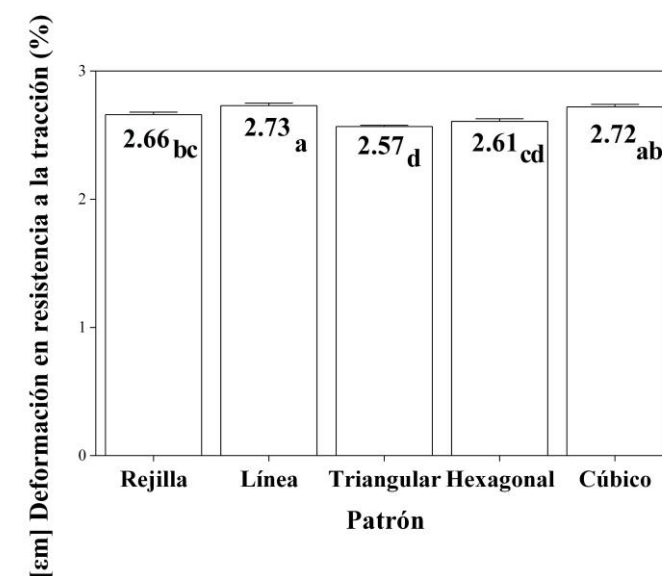
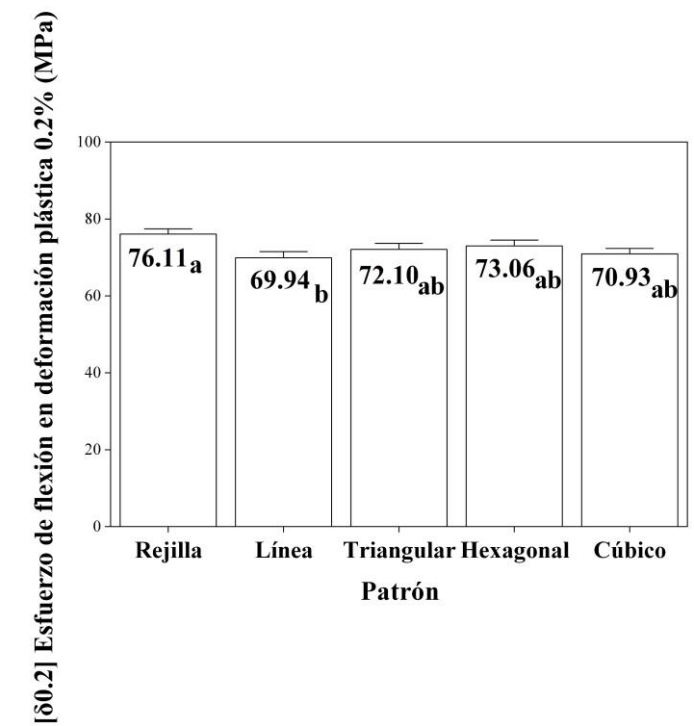
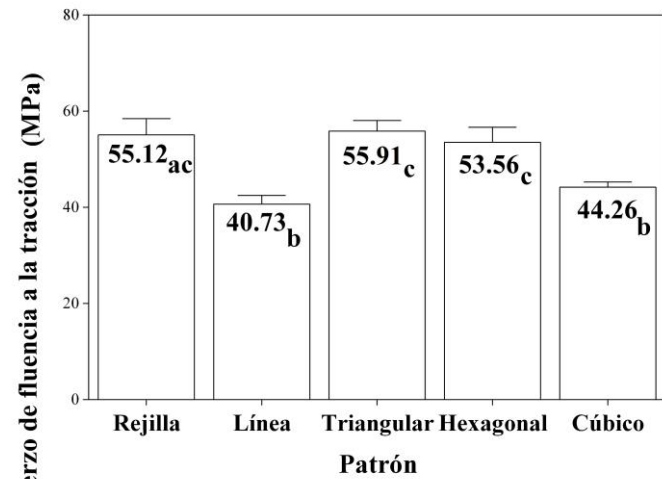



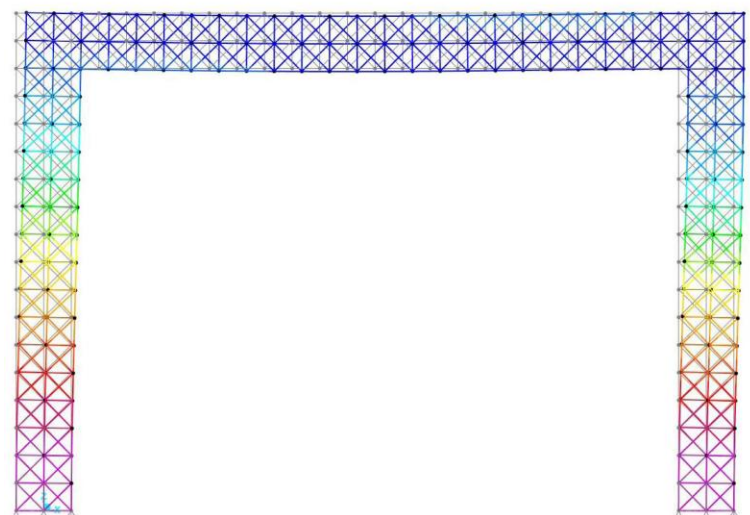
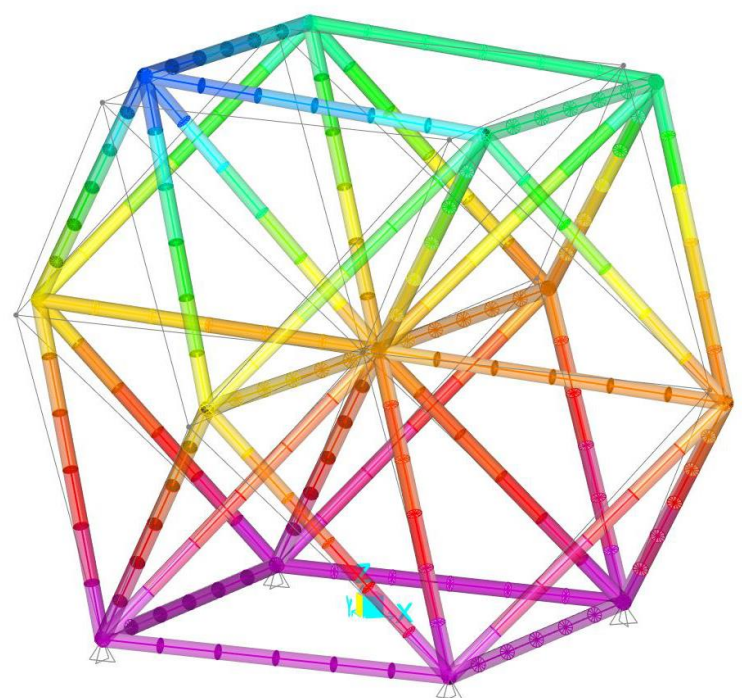
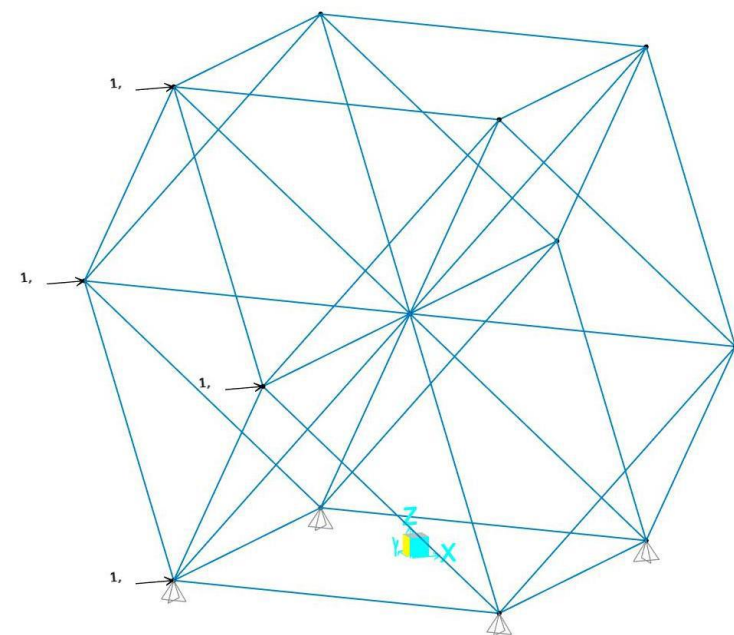
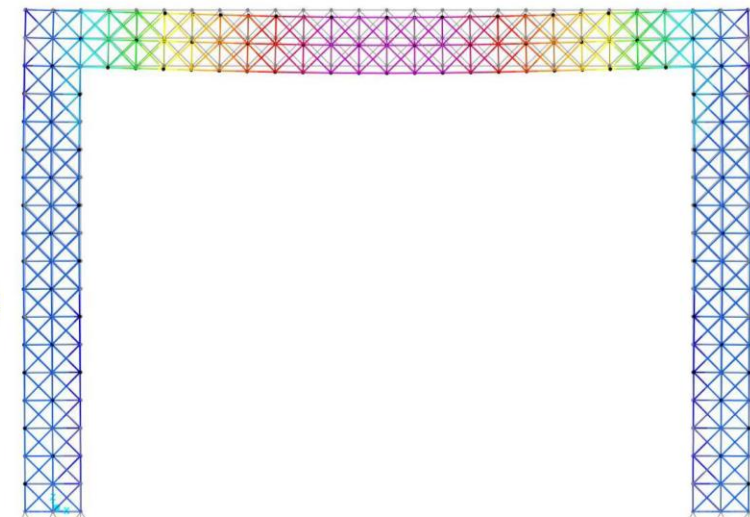
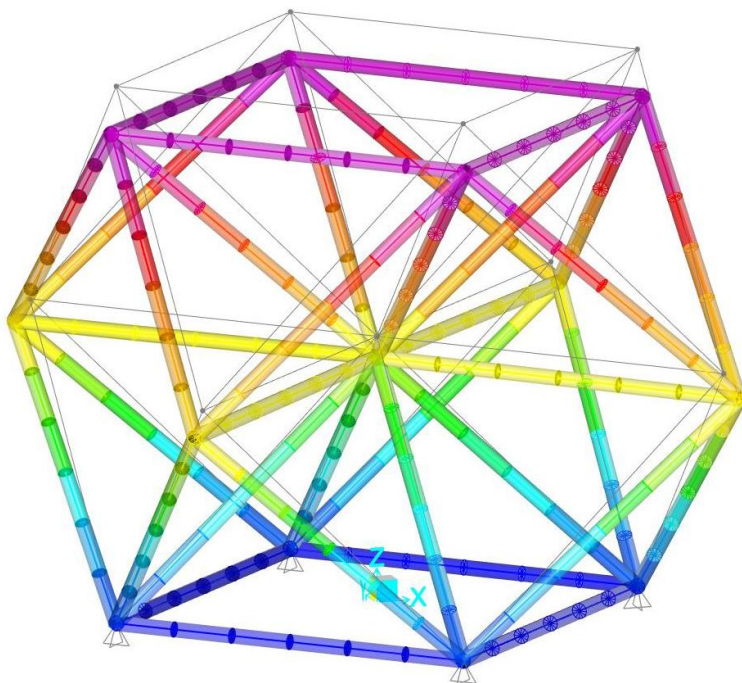
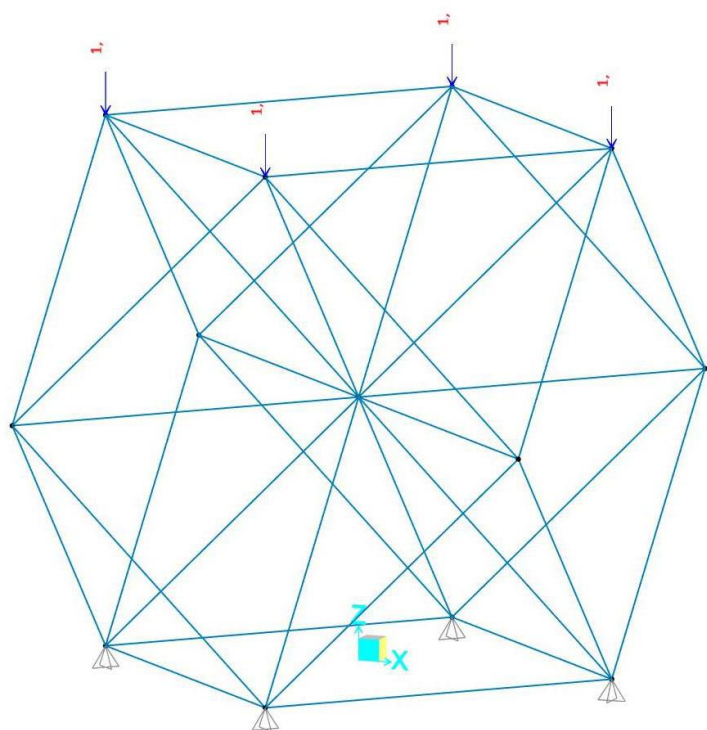
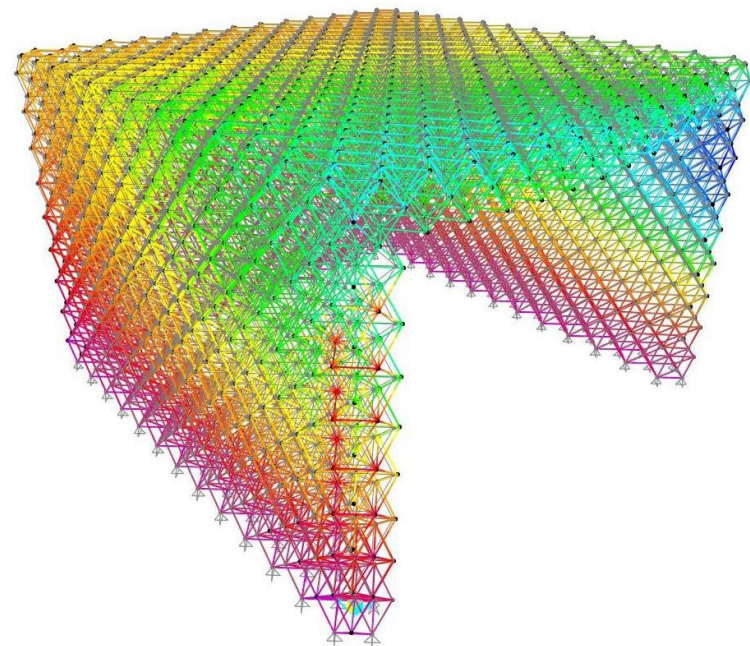
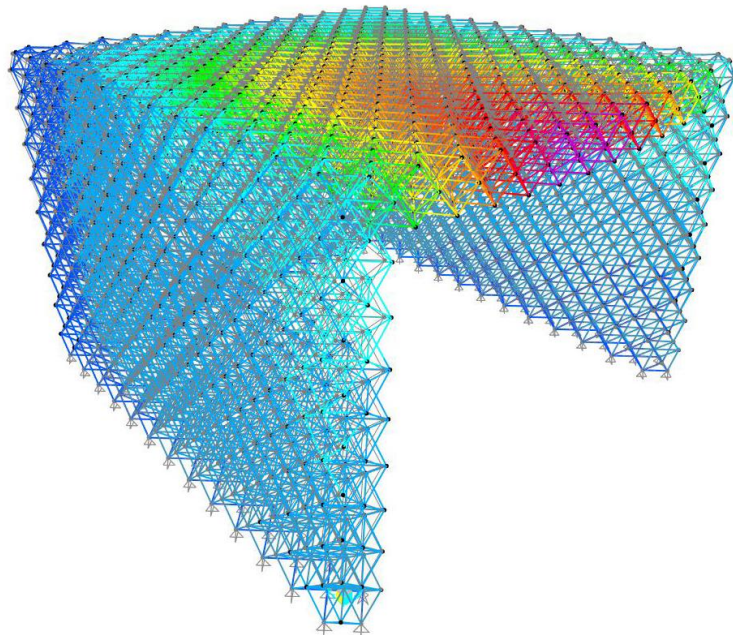
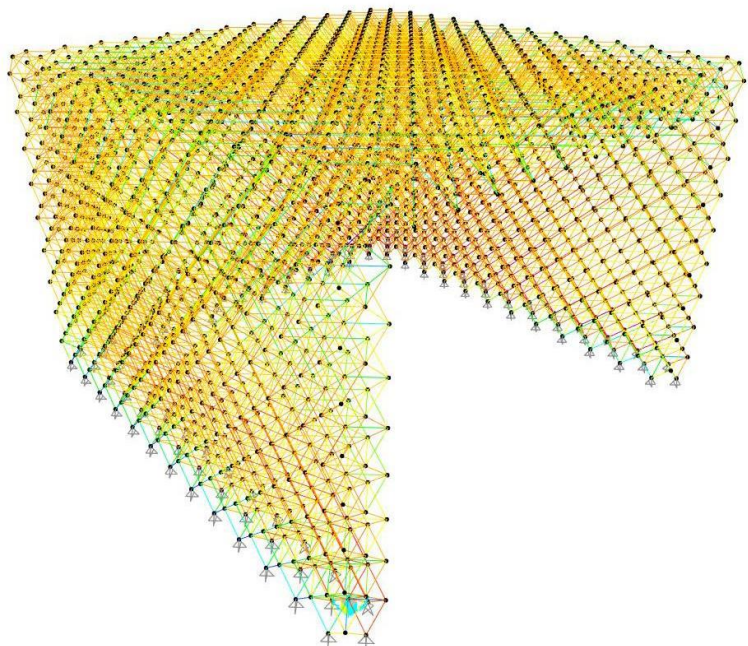







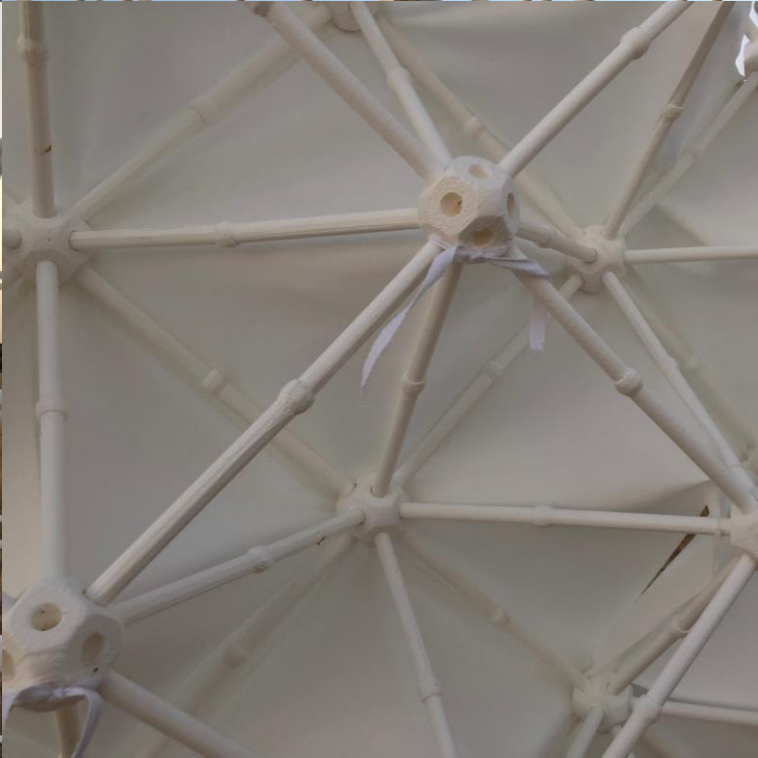
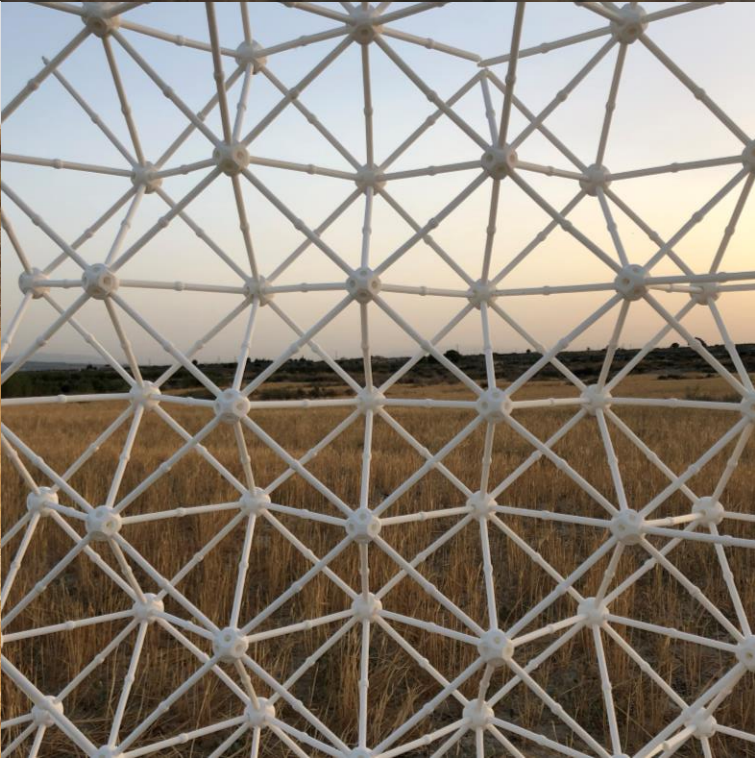











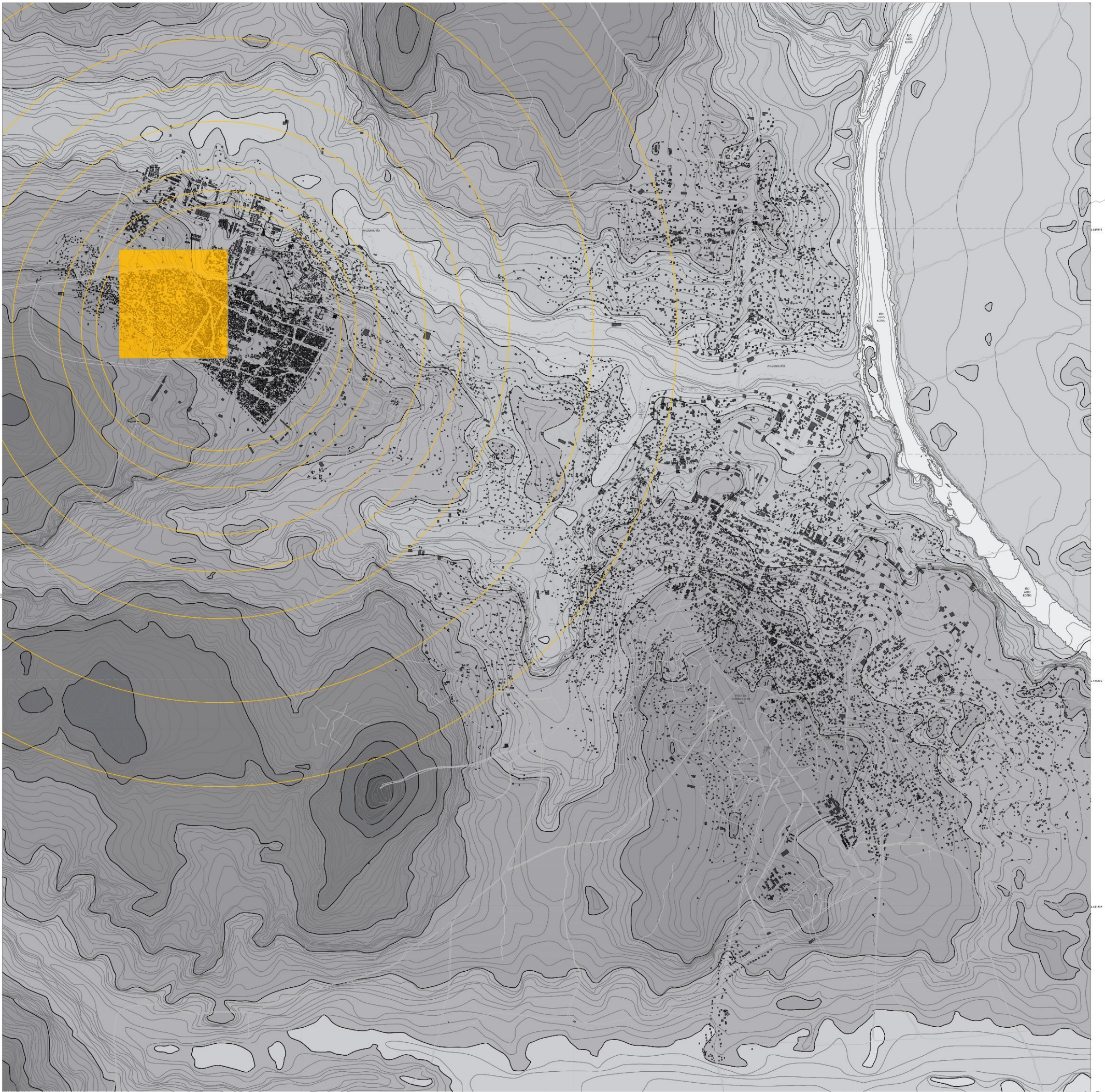

21.93162

21.94114



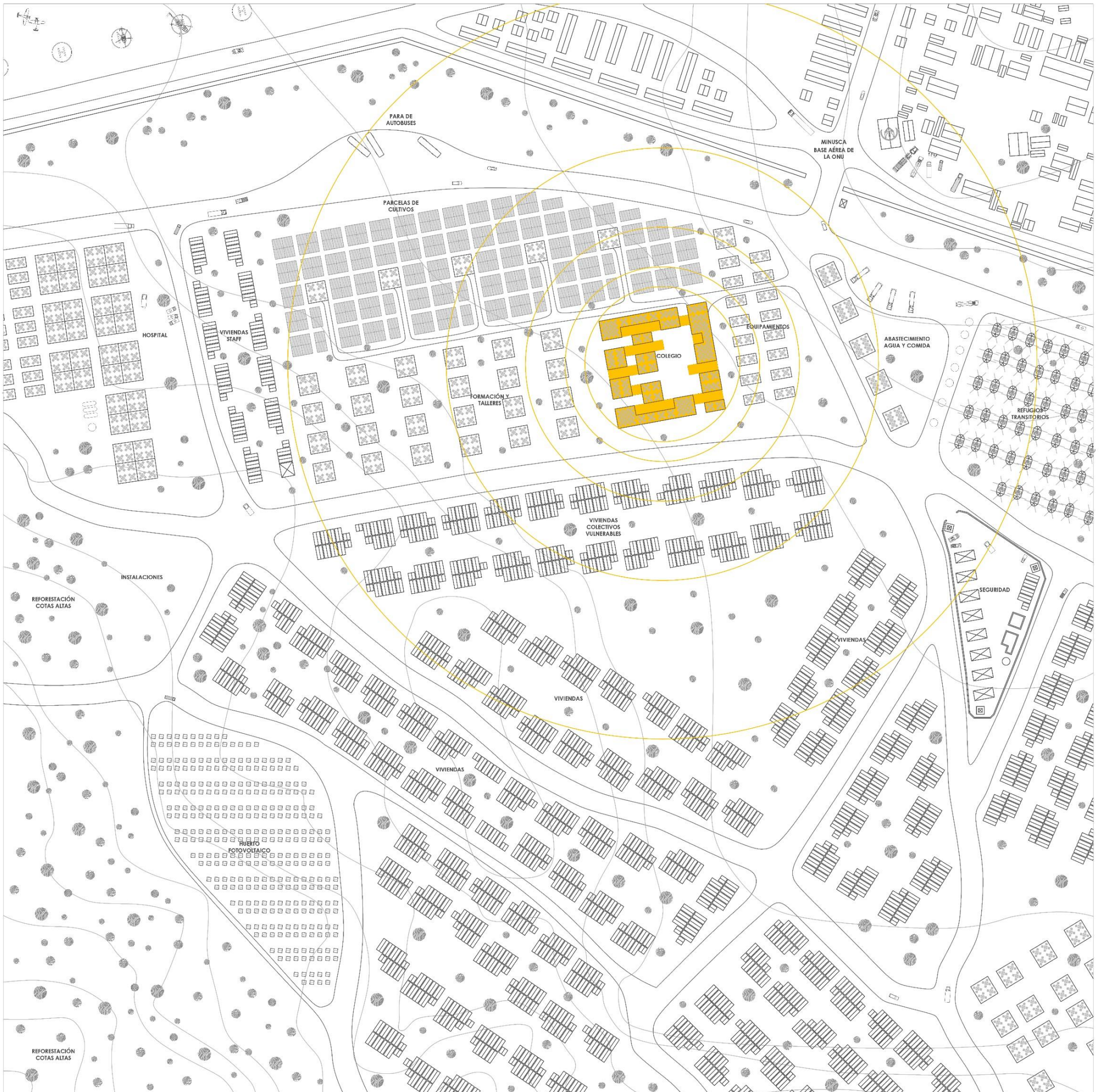



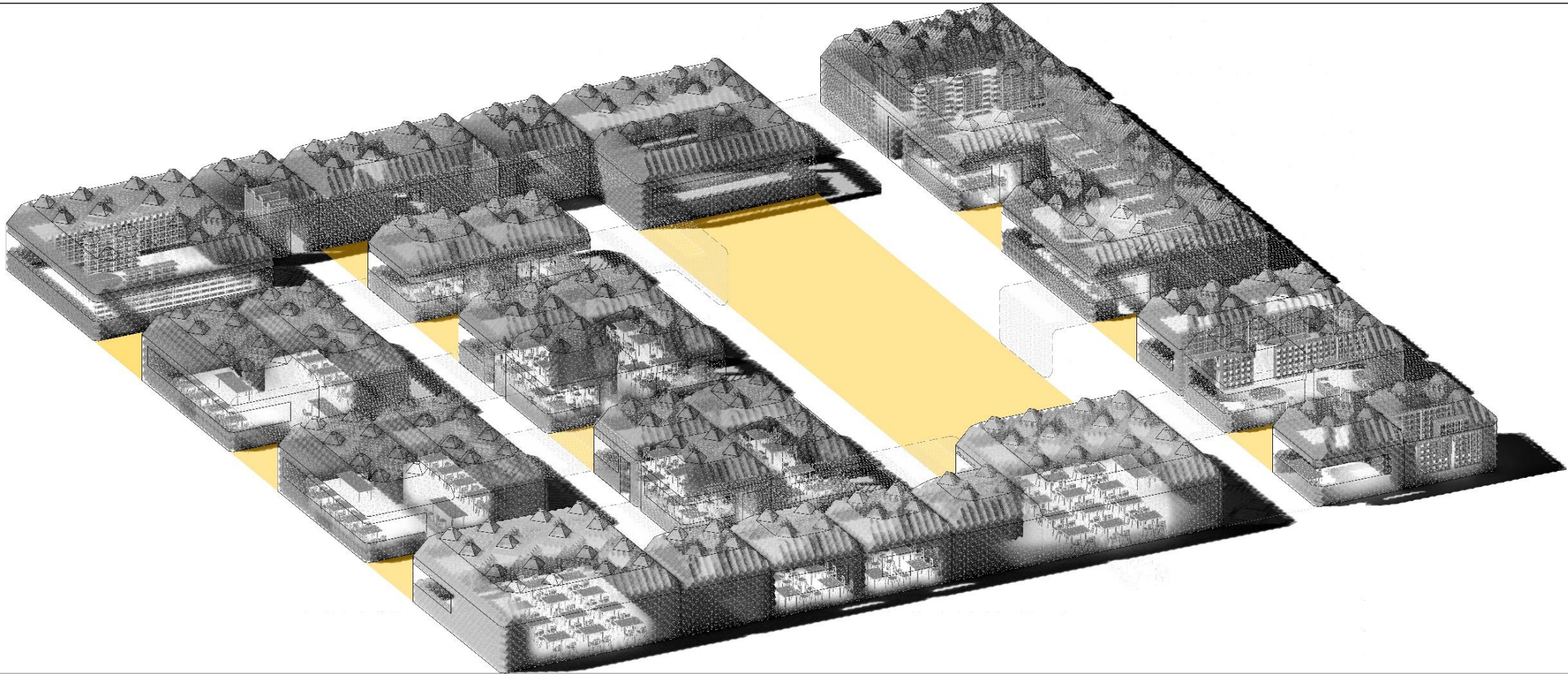



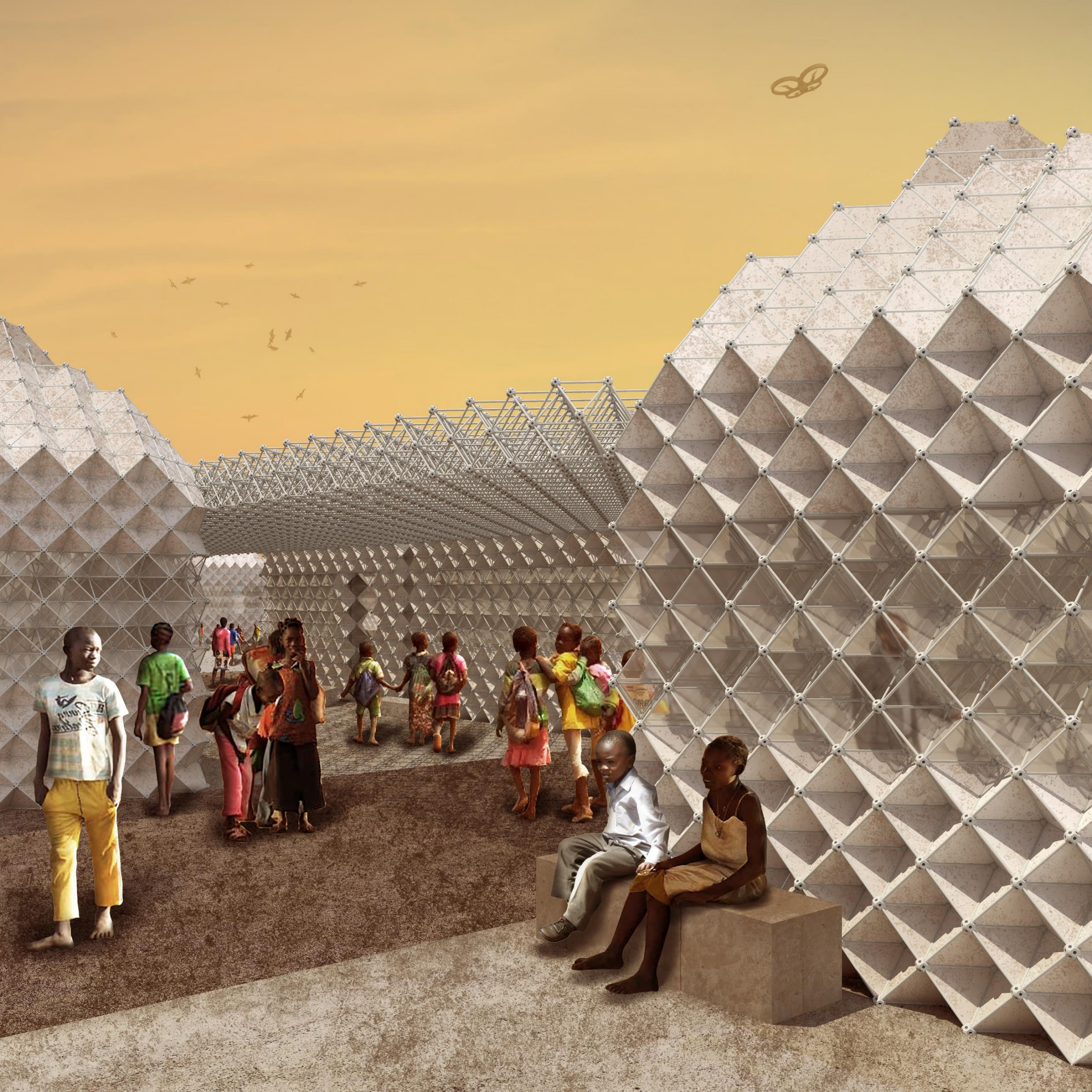



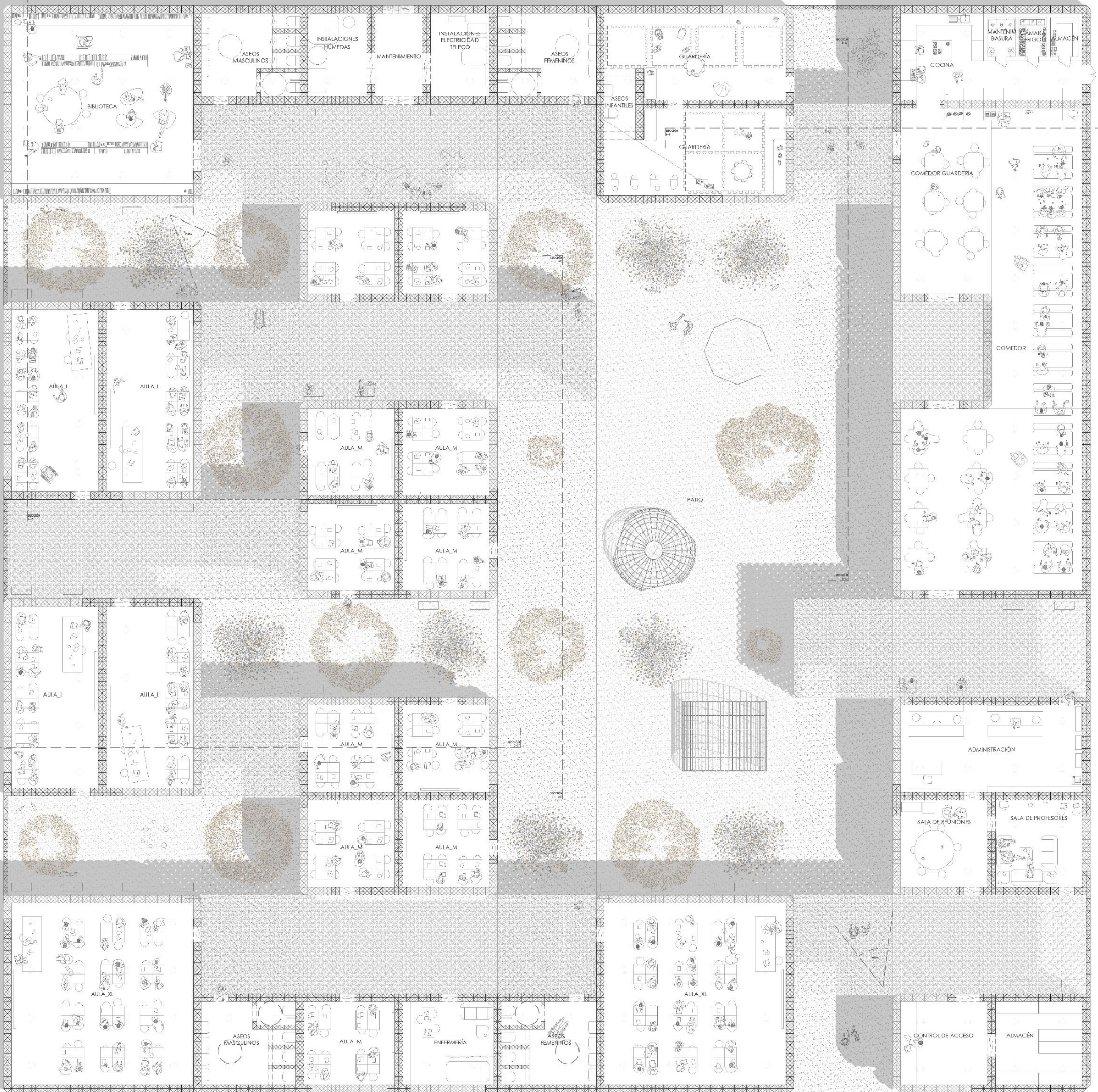



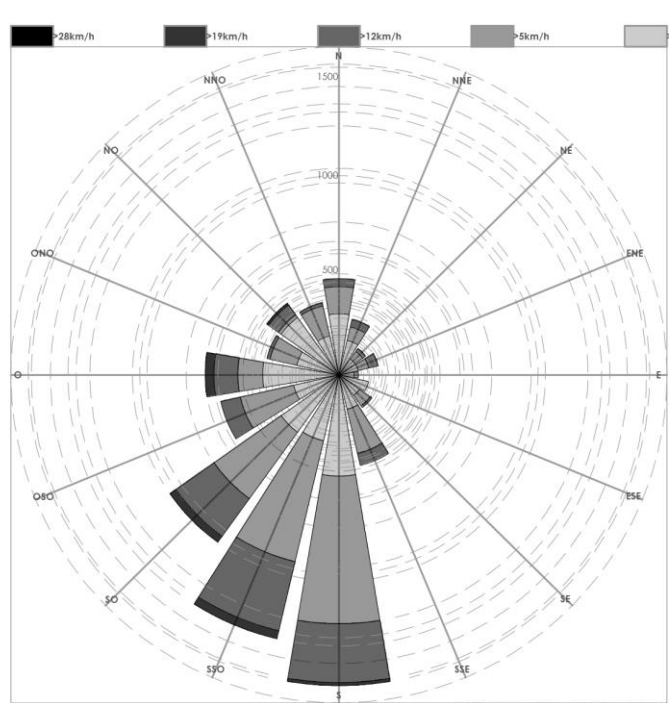
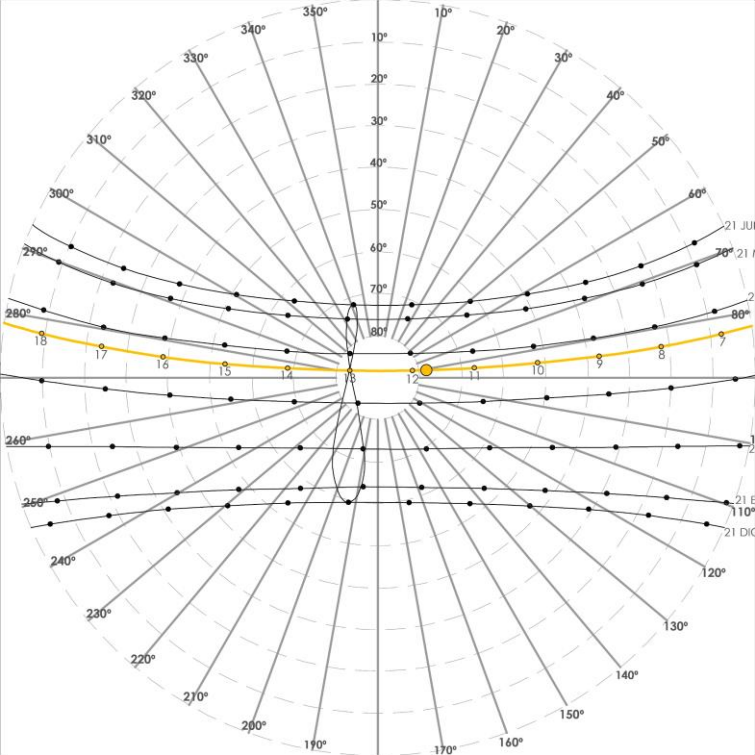

**DIAGRAMA DE VIENTO**  
DIRECCIÓN E INTENSIDAD DE VIENTOS POR HORAS ANUALES EN BRIA

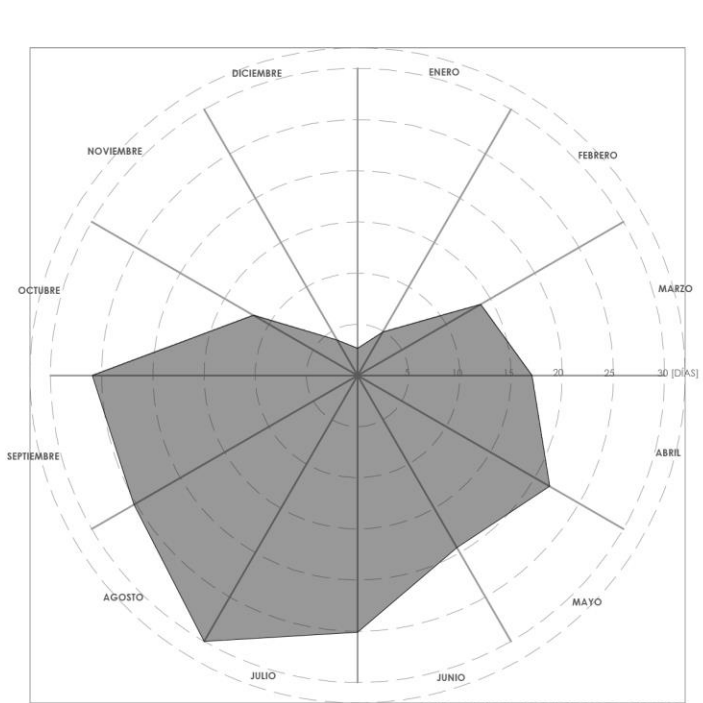

**DIAGRAMA DE PRECIPITACIONES**  
NÚMERO DE PRECIPITACIONES POR MES AL AÑO

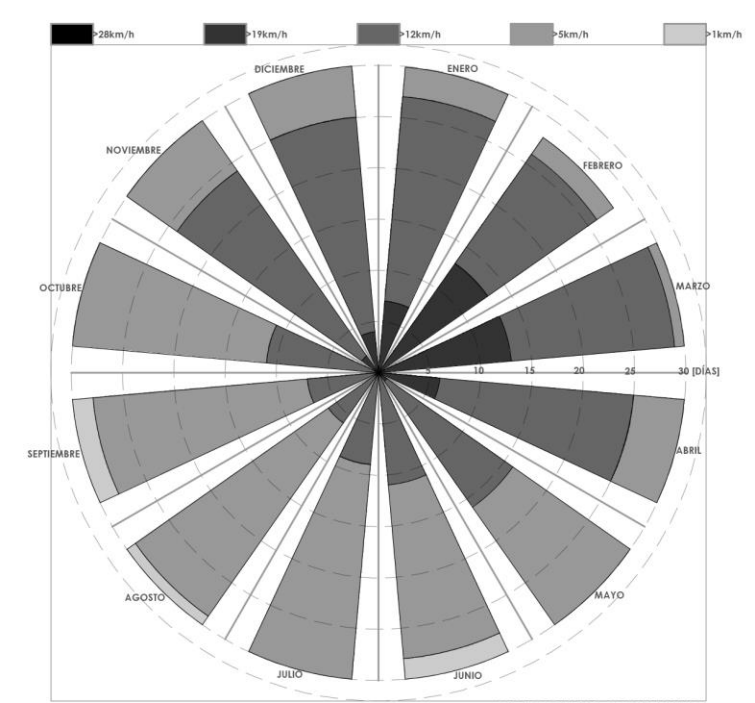

**DIAGRAMA DE VIENTO**  
REGISTRO DE VELOCIDADES MEDIAS POR NÚMERO DE DÍAS Y AÑO

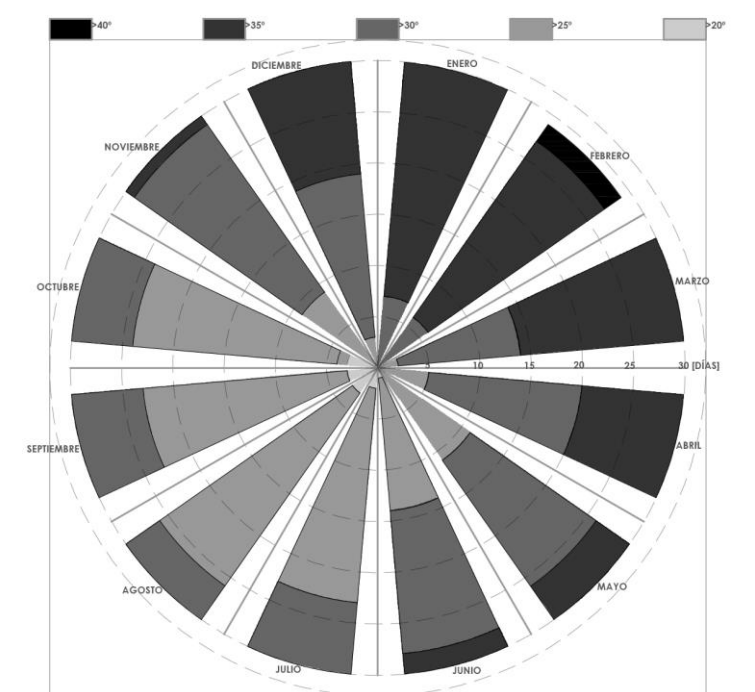

**DIAGRAMA DE TEMPERATURAS**  
REGISTRO DE TEMPERATURAS MÁXIMAS POR NÚMERO DE DÍAS Y AÑO

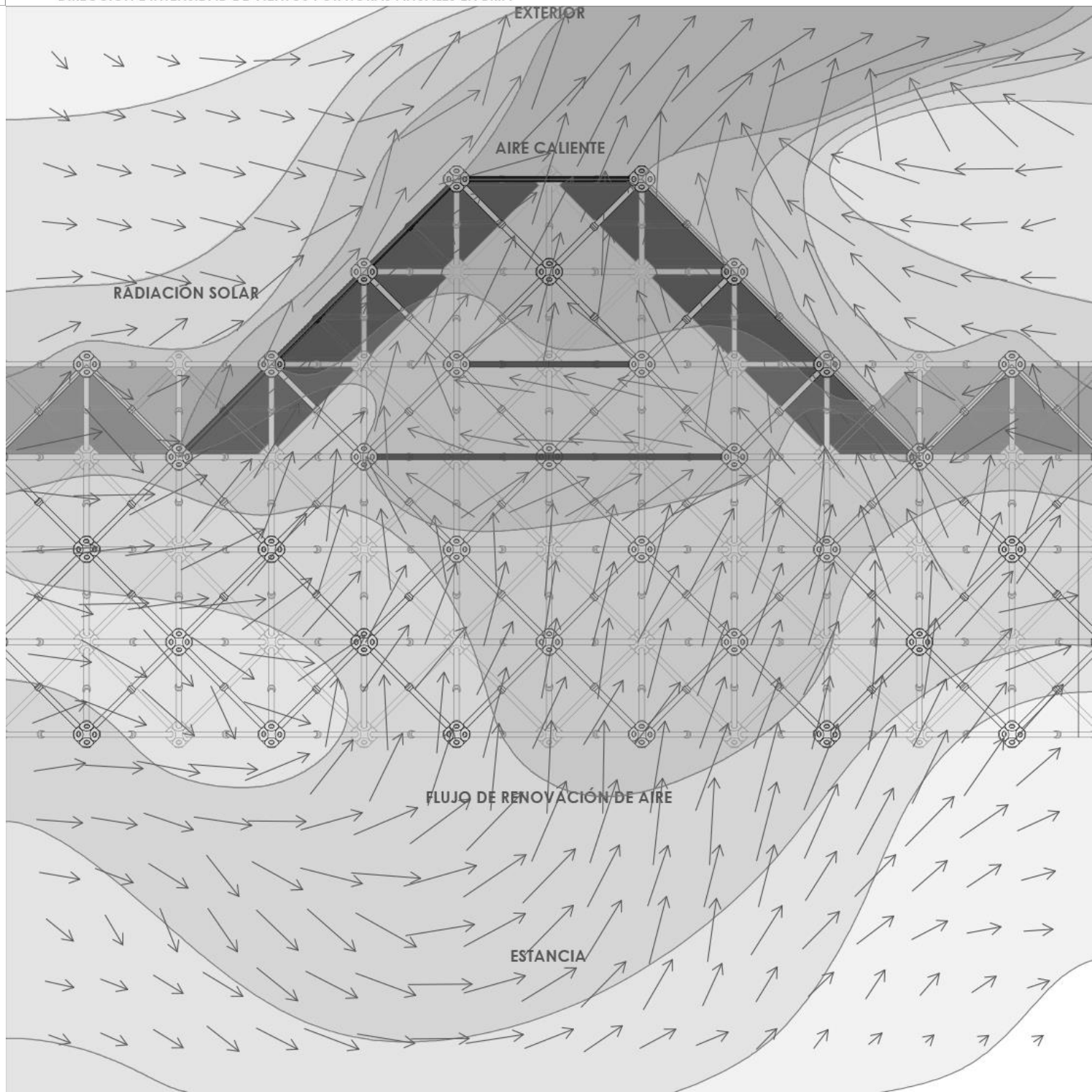



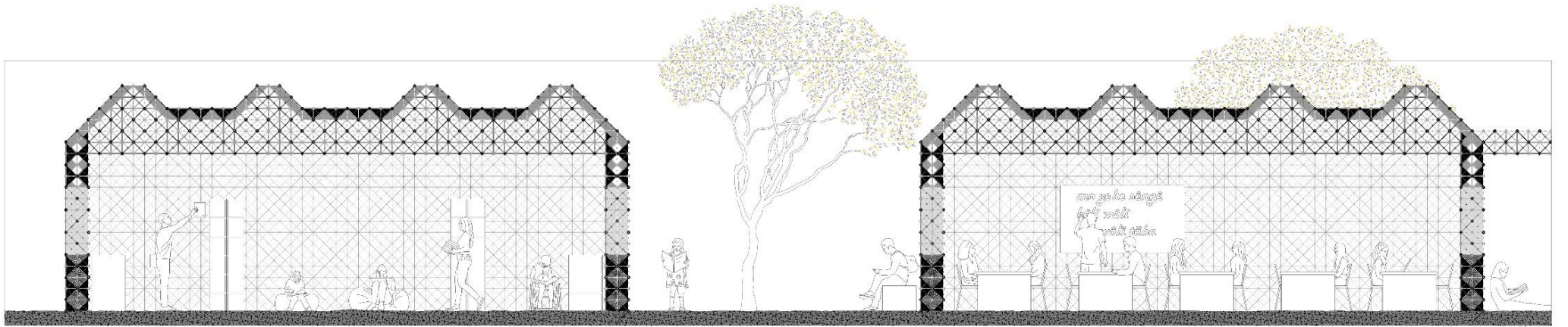

SECCIÓN A-A  
ESCALA 1\_50.

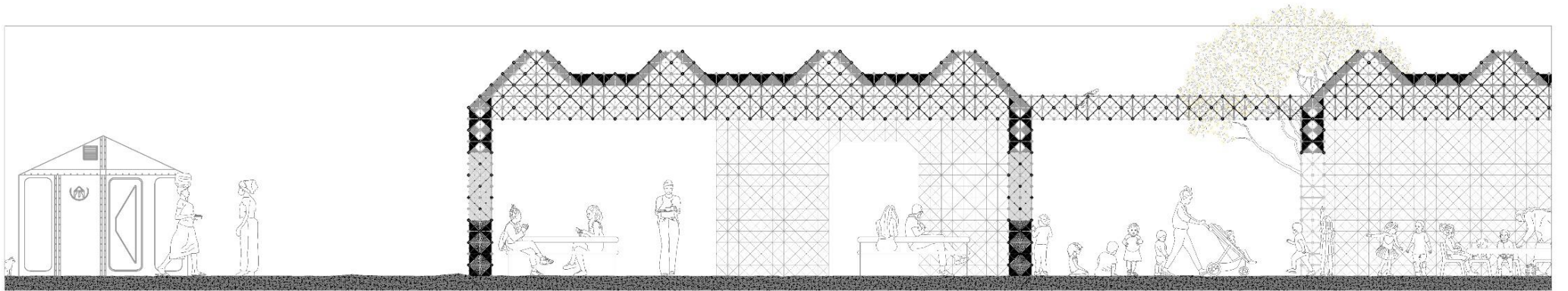

SECCIÓN B-B  
ESCALA 1\_50.

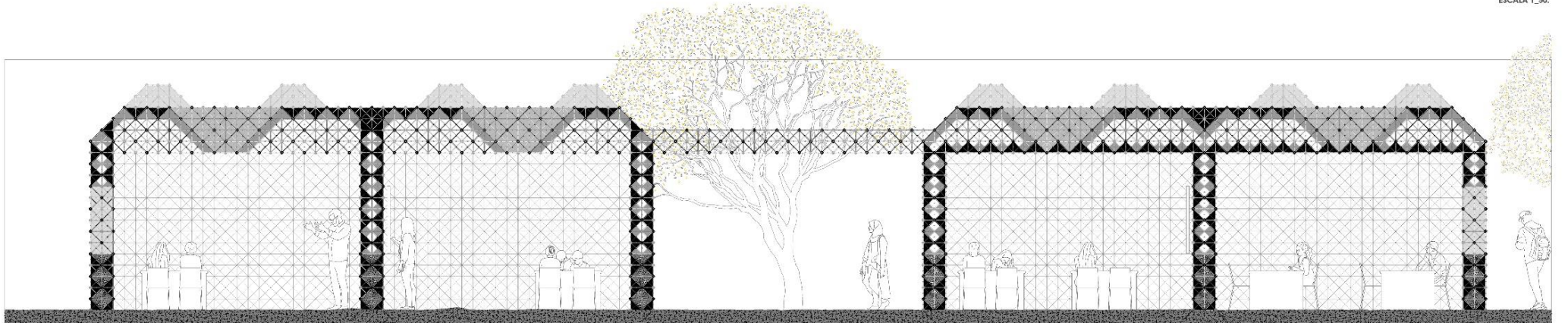

SECCIÓN C-C  
ESCALA 1\_50.



SECCIÓN D-D  
ESCALA 1\_50.

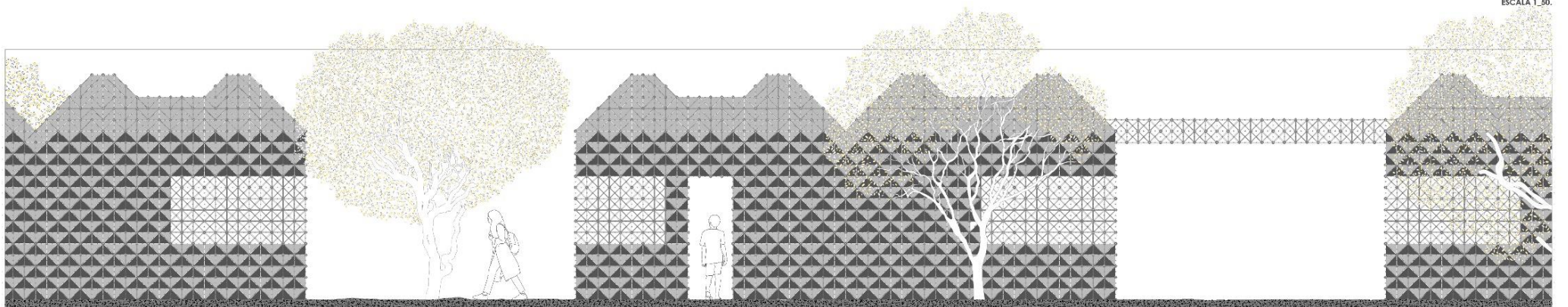

SECCIÓN E-E  
ESCALA 1\_50.



## Captadores de cubierta

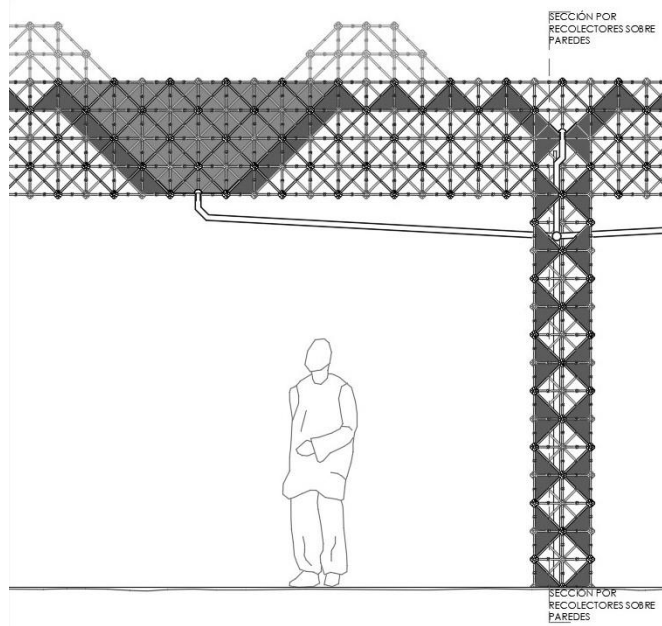

## Captadores de suelo

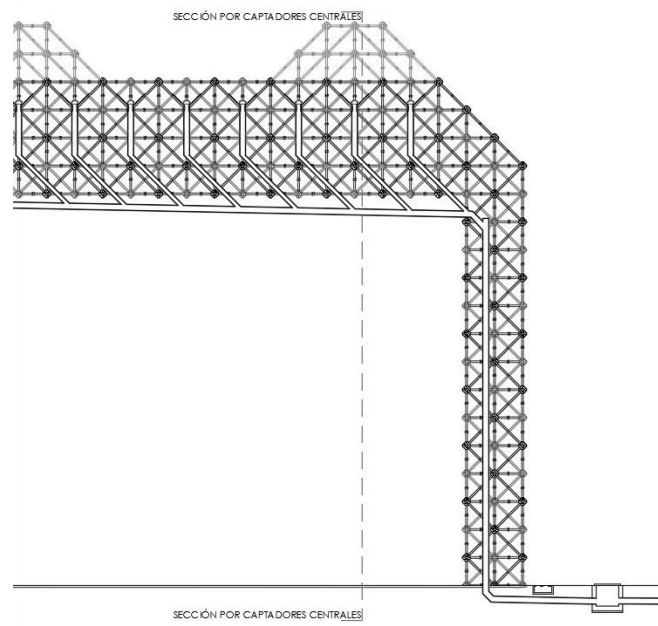

## Decantación, filtrado y depuración

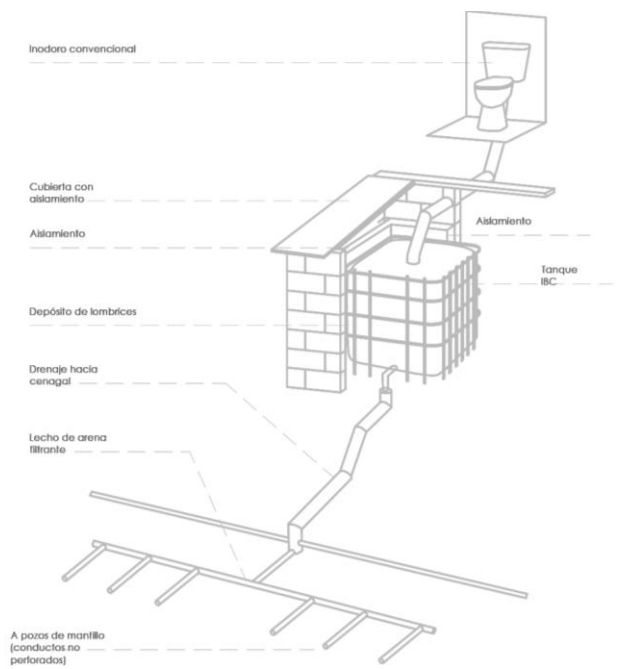
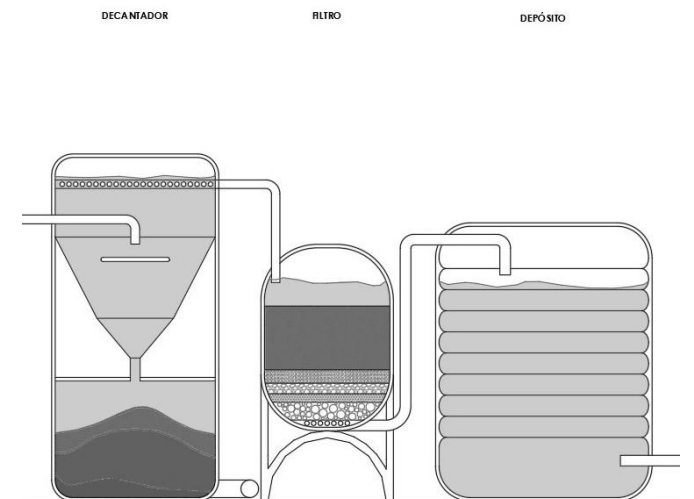





CÁMARA SÉPTICA Y DECANTACIÓN

FITODEPURACIÓN

HUMEDAL

PRE TRATAMIENTO

TRATAMIENTO CENTRAL

POST TRATAMIENTO

PRE TRATAMIENTO

TRATAMIENTO CENTRAL

POST TRATAMIENTO

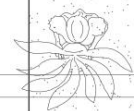
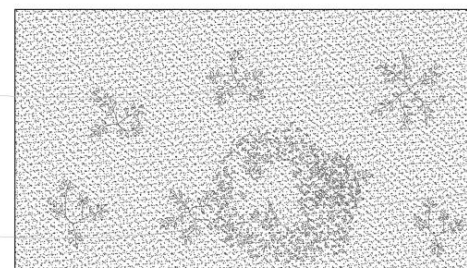
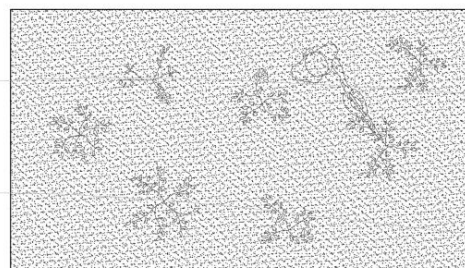
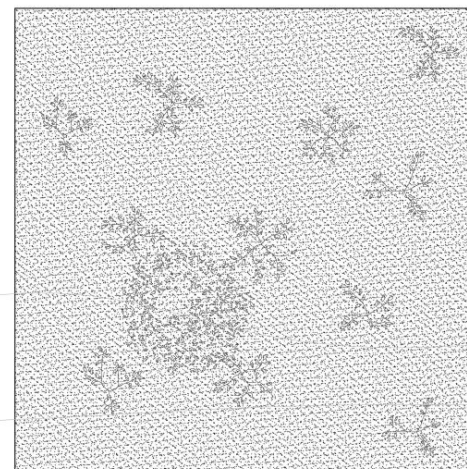
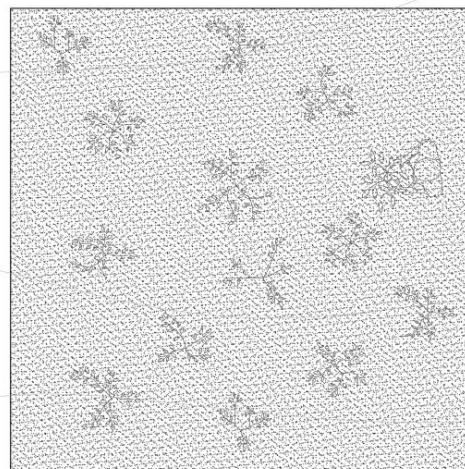
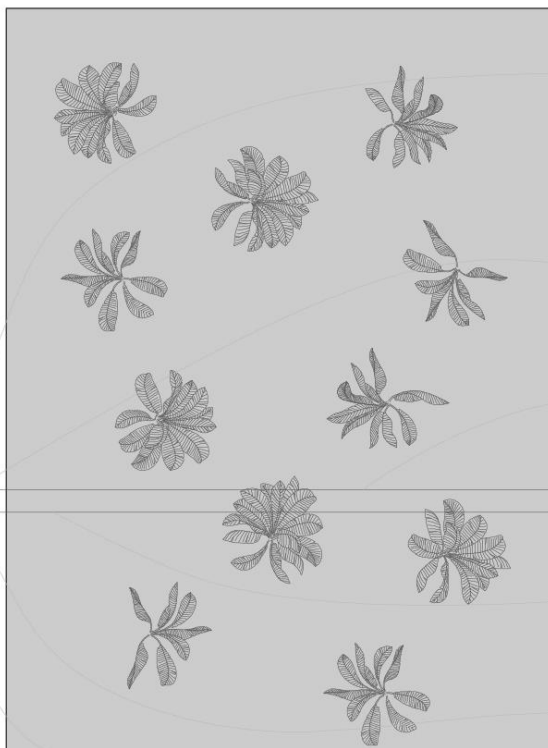
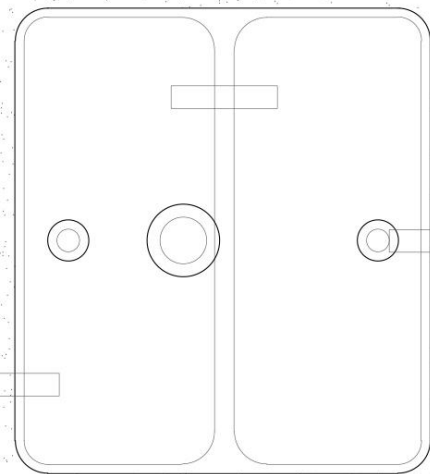



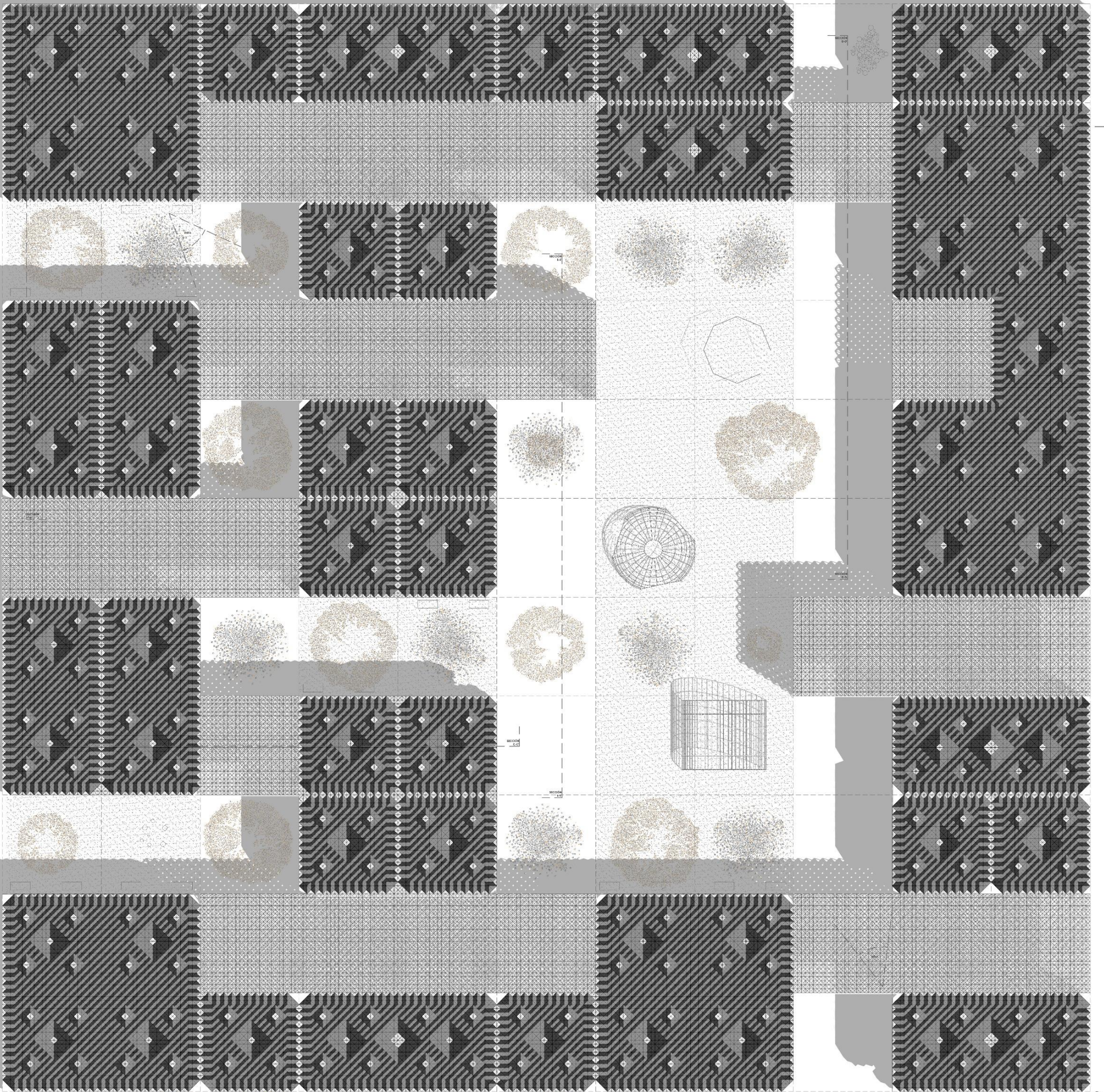







# PHASER

3D PRINTED HUMANITARIAN AID SETTLEMENTS FOR EMERGENCIES RESPONSE

VÍCTOR MARTÍNEZ PACHECO